



930F
933F
936F
939F
942F
EXCAVATOR

ALL NEW
F-SERIES

930F/933F

Engine	B6.7
Net Power	161kW
Operating Weight	31,500 - 35,400kg
Bucket Capacity	1.6m ³

936F/939F/942F

Engine	L9
Net Power	219kW
Operating Weight	38,600 - 44,000kg
Bucket Capacity	2.1m ³



TOUGH WORLD. TOUGH EQUIPMENT.

“ THE BEST MACHINES ARE DESIGNED FOR BALANCE, NOT COMPROMISE... ”

YOUR PERFORMANCE DASHBOARD

Research tells us that 6 key performance areas really matter to you. We'd like to use this performance dashboard to present the real, tough facts about our all New 30 - 42T range.



TOUGHNESS & DURABILITY



POWER & EFFICIENCY



INTELLIGENCE & CONTROL



COMFORT & ERGONOMICS



SAFETY & VISIBILITY



UPTIME & MAINTENANCE

With the All New 30 - 42T range we've built a machine which matches your performance criteria exactly. No compromises, just everything you need. It's not rocket science, it's just customer focus matched with intelligent design.

CUSTOMER DRIVEN DESIGN...

Our customers don't like compromise, nor do we. That's why we do our homework before we start the design process to really understand how our machines are actually owned and operated.

This insight allows us to perfectly balance, the demands of the machine owner and the machine operator but without compromise.



reddot design award

RED DOT AWARD-WINNING DESIGN

Our UK design team were recently recognized with a prestigious Red Dot Award for our new 4180D motor grader recognising its innovation and excellence in product design.



HERE'S THE BIG PICTURE...



POWER & EFFICIENCY

NEW

- 3 new power modes - Power, Standard and Eco

IMPROVED

- Cummins VGT technology engine delivers 5% more torque
- 20% increase on slew torque



TOUGHNESS & DURABILITY

NEW

- Heavier duty undercarriage with bilateral supported upper rollers

IMPROVED

- Longer undercarriages & increased counterweight masses
- Extra strong boom & arm - reduces stress by 25%
- 100% flaw detection



INTELLIGENCE & CONTROL

NEW

- Electro-hydraulic control technology
- Boom float technology
- Attachment flow and pressure control



ALL NEW F-SERIES

930F/933F/936F/939F/942F EXCAVATOR



SAFETY & VISIBILITY

- 360 degree camera
- Ground level daily inspection
- Anti-slip tread plates and guard rails



UPTIME & MAINTENANCE

IMPROVED

- 1,000h air filter cycle
- Component wear reduced by 70%

NEW

- 5,000 hour long life oil
- Oil bath pre-cleaner option



COMFORT & ERGONOMICS

NEW

- F-Series Ergonomic cab design
- Intuitive operator interfaces & control

IMPROVED

- Quiet (69dBA) and clean (pressurised environment)

NOW FOR THE DETAIL...

**“ NO MATTER WHAT YOU DO
TO TRUST YOUR MACHINE 100%**





**NO, YOU'VE GOT
100% ”**



TOUGHNESS AND DURABILITY

DESIGNED TO WORK HARDER, FOR LONGER



DESIGNED TO WORK HARDER, FOR LONGER...

To build machines that can withstand the hardest conditions takes intelligent design, and attention to detail. We know that a machine is only as strong as its weakest point, so every weld, every joint, every component is scrutinized to ensure it passes our rigorous durability tests. **Here's the proof.**



TOUGHNESS AND DURABILITY

1. INCREASED LOAD SUPPORT

- Upper rollers adopt bilateral support to increase the support and reduce wear

3. EXTRA VIGILANCE

100% flaw detection ensures every weld is checked to meet our stringent standards.

5. TOUGHER BOOM AND ARM

Finite element analysis proves the load efficiency and toughness of our boom and arm, but we go further to reduce stress by **25%**.

- Front and rear supports are cast, reducing welds and increasing torsional resistance
- Central ram pivot is forged to reduce stress
- EH hydraulic system reduces hoses and potential leak paths improving long-term performance

2. EXTRA PROTECTION

Deeper side beams provide higher impact resistance and make it quicker and easier to add additional impact plates if required.

4. INCREASED STABILITY

- 930F counterweight increased by 300kg to 5.8T
- 936F counterweight increased by 700kg to 7.7T

PERFORMANCE STATISTICS

1.



+10%
INCREASE
IN 936F
COUNTERWEIGHT

2.



**DEEPER
SIDE
BEAMS**

3.

100%

**FLAW
DETECTION**

5.

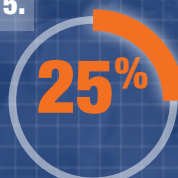

25%
STRESS
REDUCTION

1.

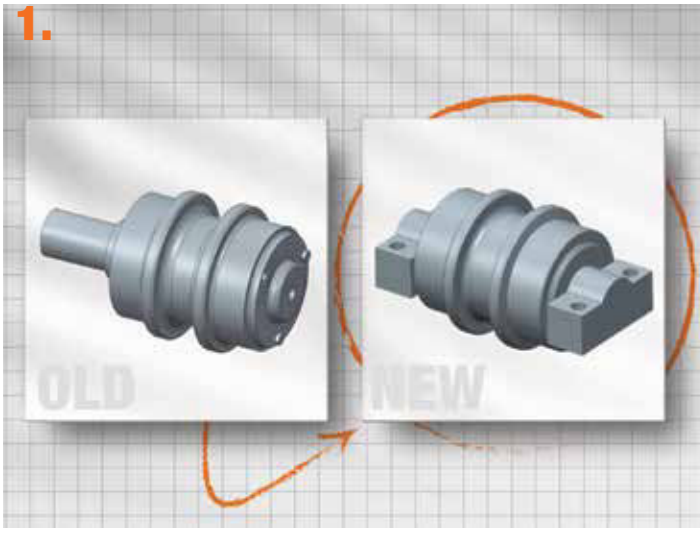

2.



3.



4.



5.

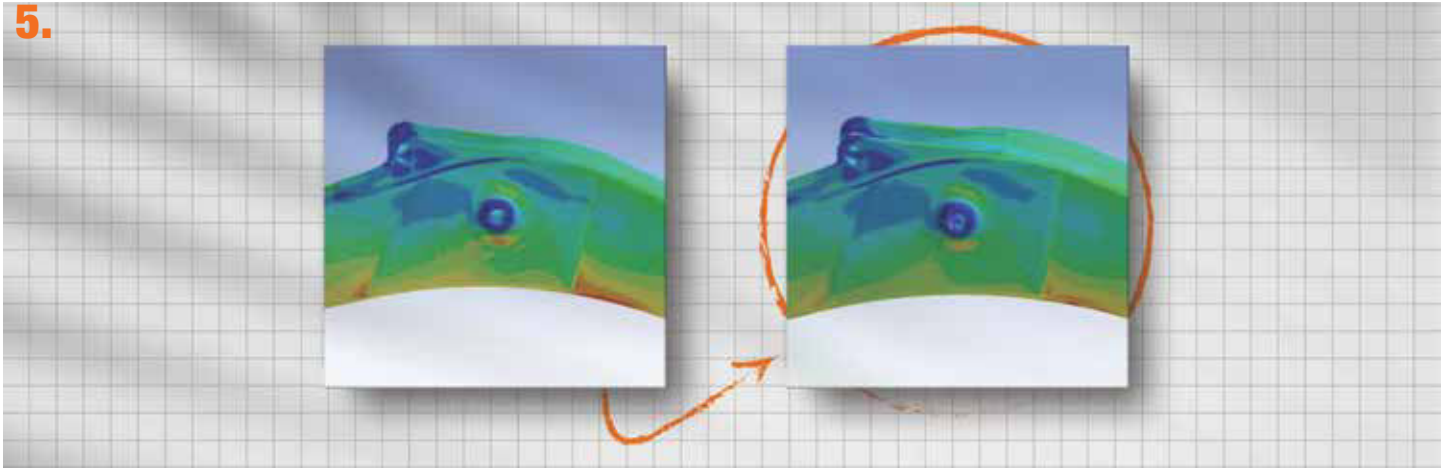

TOUGHNESS IS WHAT WE DO...

With over 50,000 excavators already working in the world's toughest environments, you can trust our machines to keep working harder - for longer.



“ WHY CHOOSE BETWEEN P EFFICIENCY WHEN YOU CAN





POWER AND EFFICIENCY HAVE BOTH? ”



POWER AND EFFICIENCY

DESIGNED TO MOVE MORE, FOR LESS



DESIGNED TO MOVE MORE, FOR LESS...

There's no need to compromise digging performance to get the highest fuel efficiency because the all New 30 - 42T range gives you both. With greater torque and more power at lower engine speeds you get the power you want and the fuel efficiency you need.



POWER AND EFFICIENCY

1. MORE REAL POWER

With VGT technology, six-cylinder Cummins engines deliver 5% extra torque compared to high torque at low engine speeds. VGT enables the engine to maximize its power output whilst creating less noise and using less fuel.

2. SAVE EVERY DROP OF FUEL

Engine Auto Idle and Auto Shutdown make every single drop of fuel count. Reducing unproductive fuel saves you money and helps protect the environment.

3. EXCEED YOUR EXPECTATIONS

When it comes to efficiency, the 30 - 42T range is smarter than you'd think. Feed Forward control technology matches the engine's speed to the operator's command and predicted load to deliver even greater fuel economy.

5. MOVE MORE FOR LESS

We are always improving our performance, with fuel consumption reduced by 10% and efficiency increased by 5% compared to the E Series, we have delivered on that promise.

4. BOOSTING YOUR PERFORMANCE

- 20% Increased Slew Torque on 930F/933F and 23% Increase of 936F/939F/942F
- Increased Travel Motor Power: 930F/933F - 6% Increase 942F - 9% Increase

EXTRA

- 942F offers increased lift performance with 20mm larger diameter boom cylinders

PERFORMANCE STATISTICS

1.

+5%

EXTRA TORQUE

5.

+10%

BETTER ON FUEL

5.

+20%

INCREASE ON SLEW TORQUE

1.

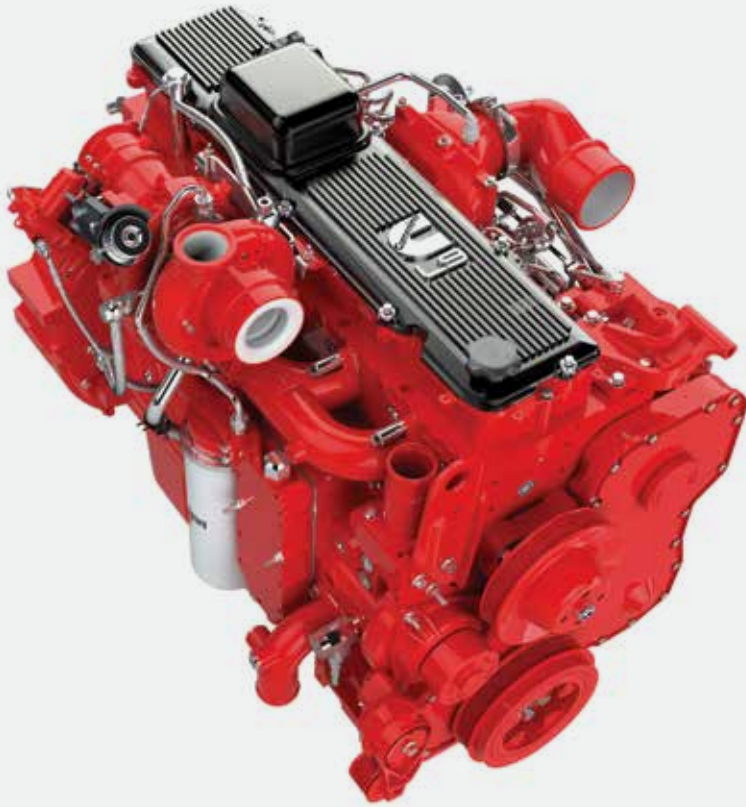

2.

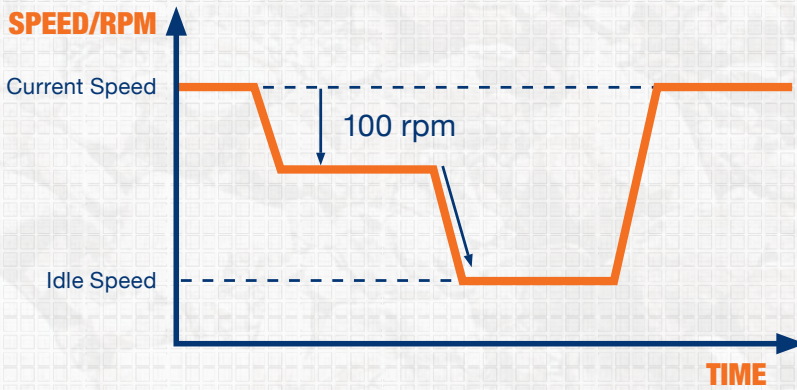

3.

FEED FORWARD

OPERATOR MOVES
JOYSTICK



PREDICTED
MACHINE LOAD

ENGINE FUELLING
CORRECTION

ENGINE SPEED
DROPS LESS



SHORTER SPEED
RECOVERY

4.



WHY COMPROMISE?

The all New 30 - 42T range let's you do more, for less cost, and with less environmental impact, don't settle for anything less.



“ TOUGH MACHINES CAN BE INTELLIGENT TOO ”





INTELLIGENCE AND CONTROL

DESIGNED TO WORK SMARTER



DESIGNED TO WORK SMARTER

Smart operators choose smart machines because they know their job is tough enough. When it comes to intelligence and control the all New 30 - 42T range may surprise you as it's packed with smart features to make life easier.



INTELLIGENCE AND CONTROL

1. CHOOSE YOUR MODE

With a choice of 3 Integrated Work Modes each designed to match the engine speed, pump flow and system pressure to your chosen application, it's easy to find the perfect balance of performance and economy.

2. ELECTRO-HYDRAULIC CONTROL

The state-of-the-art full electro-hydraulic system from Kawasaki provides lightening fast signals between the joysticks, pumps and valve blocks to deliver pin point precision and maximize available engine power.

3. USE OUR BRAINS

With a suite of Smart functions at your fingertips you can control your attachment properties from the comfort of your cab. It's easy:

- Adjustable flow control
- Adjustable pressure control
- 10 attachment settings

4. INCREASED HYDRAULIC PERFORMANCE

- 936F/939F/942F features a larger pump with 11% increased flow

5. WORK SMARTER WITH BOOM FLOAT

Improves performance and prolongs tool life by preventing excessive pressure during braking applications.

Perfect for smooth levelling and deep excavation work, this smart function reduces fuel consumption by allowing the boom to fall under its own mass.

PERFORMANCE STATISTICS

2.

+11%

INCREASE
ON 936F
/ 939F /
942F

3.

-10%

REDUCTION IN FUEL
CONSUMPTION

1.

x3

DEDICATED
POWER
MODES

4.

x10

ATTACHMENT
SETTINGS

1.



ECONOMY (E) MODE
FOR LIGHT WORK



STANDARD (S) MODE
FOR STANDARD OPERATION



POWER (P) MODE
FOR HEAVY DUTY

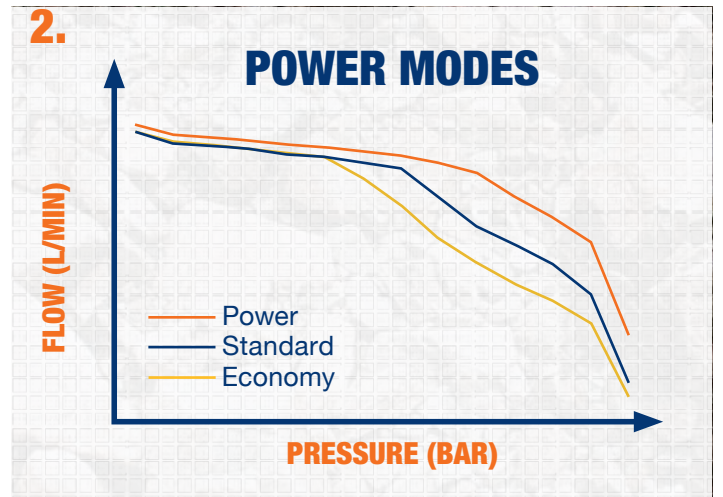

SMART IDEAS IN ACTION

The all New 30 - 42T range has the perfect balance of toughness and intelligence designed to keep you in control.

**“ TOUGH DAYS GO FASTER
YOU’RE WORKING IN COMFO**





**WHEN
RT ”**

UGONG

COMFORT AND ERGONOMICS

DESIGNED AROUND THE OPERATOR



DESIGNED AROUND THE OPERATOR

Climb into the spacious cab and you'll know that it has been designed by a team that really knows what its like to be an operator. Talking, listening and observing operators, our design team spend almost as much time in the cab as they do with the CAD. The result? One of the most ergonomic and comfortable cabs you can get.



COMFORT AND ERGONOMICS

1. PERFECT CONTROL

- From the ergonomically positioned non-slip pedals to the multi-functional joysticks, the cab interior represents a masterclass in design.
- Every action and movement requires the minimum of effort from the operator.
- Boom float, travel speed and proportional auxiliary controls are customizable and fingertip controlled - you can even mute your music!

3. YOUR CHOICE OF SEAT

Every operator is different, so we offer a range of seats and joystick configurations to suit everyone.

- Mechanical suspension standard seat
- Comfort level, air suspension seat with adjustable lumbar support.
- Luxury level, heated air suspension seat with adjustable lumbar and premium padding.

5. IT'S SO QUIET

Our latest F Series cabin and sound insulation system dramatically reduces the noise in cab by as much as 3dB on the 930F/933F and 6dB on the 936F/939F/942F.

2. INTUITIVE INTERFACE

We've designed the operator interface to be even more intuitive and easy to use. The large 8-inch LCD colour screen can be controlled via touchscreen or by a fingertip navigational control dial conveniently sited in the armrest control panel.

4. MAKE IT YOUR PLACE

We never forget that a machine is not just a tool, it's your place for many hours a day (and night). So, we've remembered all the little things that make it feel like home.

- Cool box for food & drinks
- Large storage box and rack
- Drinks holder
- Phone holder with 12V charging, USB and AUX ports

TICKS ALL THE RIGHT BOXES

INTUITIVE LCD OPERATOR CONSOLE

ERGONOMIC LAYOUT

FULLY PRESSURIZED (100PA)

ADVANCE AIR-CON AND TEMPERATURE CONTROL

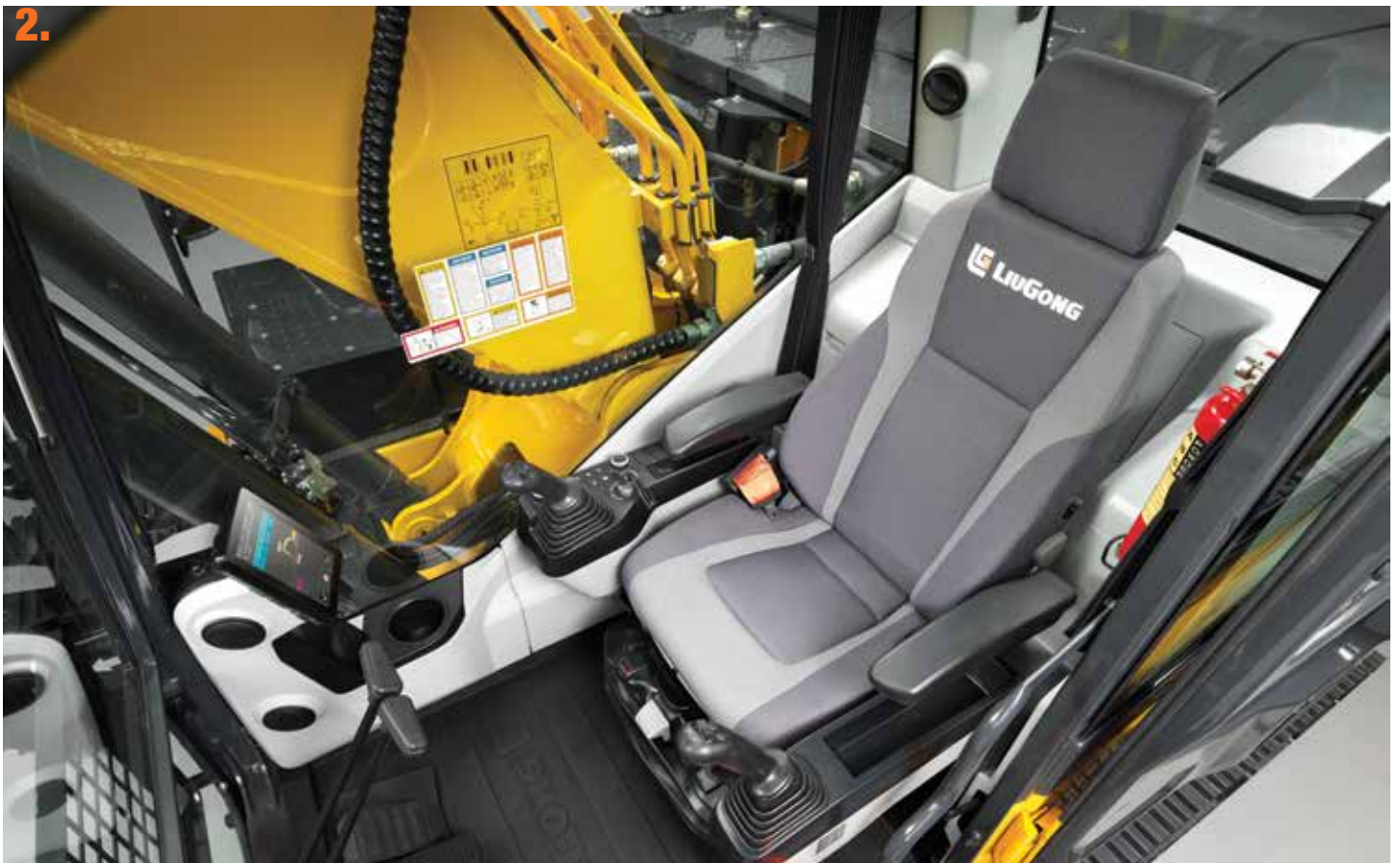

PERFECTLY MATCHED TO YOU

The all New 30 - 42T range gives you the operating environment you would design for yourself.

ENHANCED VISIBILITY

CUSTOMIZABLE OPERATING HANDLE

HIGH COMFORT, FULLY ADJUSTABLE SEAT

LOW NOISE AND LOW VIBRATION

**“ WE CONSTANTLY ASK...
MAKE OUR MACHINES EVEN**





HOW CAN WE SAFER ””



SAFETY AND VISIBILITY

DESIGNED TO PROTECT



SAFER ALL-ROUND ACCESS

Being protected in the cab is important, but accident research shows us that most accidents occur outside of the machine. We've taken the challenge to make our machines even safer to be around.



SAFETY AND VISIBILITY

1. MORE PROTECTION WHERE YOU NEED IT

The driver protection system delivers even greater protection to the front and top of the cab and protects the operator from falling rocks and debris. The front screen has a hinge design making cleaning and maintenance easier.

2. WATCH YOUR STEP

- The new 0.5m wide stepped boarding channel with non-slip treadplates makes getting on and off the machine safer
- The engine compartment features a gripped access platform.
- Optional guard rails or integral fences on the left and right sides of the upper platform increase safety.

3. EMERGENCY STOP

The ground level emergency stop switch is fitted as standard.

4. BE SAFE. BE SEEN

LED work light for better night visibility is fitted as standard.

5. SEE THE WHOLE SITE

Our cab design provides the operator with the very best view of the site, from every angle. Smart design ideas such as integrating the steps into the line of the cabin, improve visibility on the right hand side giving a 180 degree view.

6. SAFER MAINTENANCE ACCESS

No need to climb on the machine, all the daily maintenance points, including the oil level check point are easily accessible from the ground.

7. NO BLIND SPOTS

With 360 degree camera as standard in Europe, you can get an uninterrupted panoramic view around the machine at all angles from the large LCD screen.

BETTER BY DESIGN

LiuGong's Red Dot Award winning design* team is rapidly building a reputation for un-matched visibility. When you can see more you can do more, whilst protecting yourself and people around the machine.

With the All New 30-42T we've pushed the barriers and taken visibility another step forward.

*4180D Motorgrader



red*dot* design award



YOUR SAFETY - OUR PRIORITY

The all New 30 - 42T range has the perfect balance toughness and intelligence designed to keep you in control.

“ CAN DAILY MAINTENANCE
AS SIMPLE AS THIS? ”





E REALLY BE



UPTIME AND MAINTENANCE

DESIGNED TO BE EASY TO SERVICE AND MAINTAIN



EASY TO OWN AND EASY TO MAINTAIN

We understand that when your machine's not working, it's not earning. To maximize your productive hours, we've made the All New 30-42T even easier to maintain, helping you make every productive second count.



MAINTENANCE AND UPTIME

1. FULLY SYNCHRONIZED MAINTENANCE

Maintenance should be simple so to save you time, all engine oil filter replacement cycles have been synchronized.

2. SPACE FOR YOUR KIT

We've increased the storage space behind the cab and added a segregating tray to create a useful space for your maintenance kit such as grease guns and lifting equipment.

3. NO RISK - LOW LEVEL ACCESS

Convenience and safety should never be compromised.

- ✔ The easy to access optional re-fuelling pump is safely stowed behind the bay door.
- ✔ All filters are located close to the bay doors for safe access and speedy maintenance.
- ✔ To aid access to the upper structure, a second access ladder behind the cabin offers additional convenience to the operator.

4. MAKING IT FASTER EVERYDAY

By grouping the greasing points together on the boom base, top of the dipper and slew bearing we make daily maintenance faster and easier. Optional automatic lubrication pipeline gives you easy access to all the lubrication points in one place, saving you even more time on daily maintenance.

5. 5000 HOUR OIL LIFE

New long life hydraulic oil reduces total cost of ownership and saves service maintenance time.

PERFORMANCE STATISTICS

500mm

WIDE ACCESS STEPS

5.

5000 hour

HYDRAULIC OIL LIFE

5.

-20%

LOWER MAINTENANCE COSTS

3.

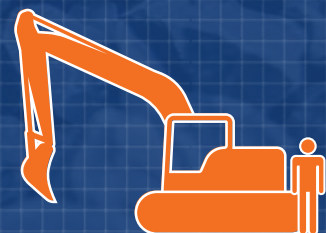

GROUND LEVEL MAINTENANCE



SPECIFICATIONS

OPERATING WEIGHT

930F	31,600 kg (70,222 lbs)
933F	34,300 kg (76,222 lbs)
936F	38,800 kg (86,222 lbs)
939F	39,800 kg (88,444 lbs)
942F	42,800 kg (95,111 lbs)

Operating weight includes coolant, lubricants, full fuel tank, cab, standard shoes, boom, arm, bucket and operator 75 kg (165 lbs).

Bucket Capacity	930F	1.4 m ³ (1.8 yd ³)
	933F	1.4 m ³ (1.8 yd ³)
	936F	1.8 m ³ (2.35 yd ³)
	939F	2.0 m ³ (2.62 yd ³)
	942F	2.1 m ³ (2.75 yd ³)

HYDRAULIC SYSTEM

Main pump

Type	Load-sensing variable pump
------	----------------------------

Maximum flow	930F/933F	2 × 266 L/min (2 × 70.3 gal/min)
	936F/939F/942F	2 × 333 L/min (2 × 88 gal/min)

Relief valve setting

Implement	34.3 MPa (4,975 psi)
Travel circuit	34.3 MPa (4,975 psi)
Slew circuit	32.4 MPa (4,699 psi)
Pilot circuit	3.5~3.9 MPa (508~566 psi)

Hydraulic cylinders

Boom Cylinder – Bore × Stroke	930F/933F	Φ140 × 1,342 mm (Φ5.5" × 4'4")
	936F/939F/942F	Φ140 × 1,505 mm (Φ5.5" × 4'11")

Arm Cylinder – Bore × Stroke	930F/933F	Φ150 × 1,755 mm (Φ5.9" × 5'9")
	936F/939F/942F	Φ175 × 1,785 mm (Φ6.9" × 5'10")

Bucket Cylinder – Bore × Stroke	930F/933F	Φ140 × 1,135 mm (Φ5.5" × 3'8")
	936F/939F/942F	Φ160 × 1,250 mm (Φ6.3" × 4'1")

ELECTRIC SYSTEM

System Voltage	24 V	
Batteries	2 × 12 V	
Alternator	24 V - 70 A	
Start motor	930F/933F	24 V-7.8 kW (24 V-10.5 hp)
	936F/939F/942F	24 V-8 kW (24 V- 0.7 hp)

ENGINE

Description

930F/933F	Cummins B6.7
936F/939F/942F	Cummins L9

Emission rating EU Stage V

Engine manufacturer	Cummins
---------------------	---------

Engine model	930F/933F	B6.7
	936F/939F/942F	L9

Aspiration Turbo

Charged air cooling /

Cooling fan drive Direct

Displacement	930F/933F	6.7 L (1.77 in ³)
	936F/939F/942F	8.9 L (2.35 in ³)

Rated speed	930F/933F	2,000 rpm
	936F/939F/942F	2,100 rpm

Engine output - net (SAE J1349 / ISO 9249)	930F/933F	161 kW (219 hp)
	936F/939F/942F	219 kW (298 hp)

Engine output - rated (SAE J1995 / ISO 14396)	930F/933F	173 kW (235 hp)
	936F/939F/942F	231 kW (314 hp)

Maximum torque	930F/933F	949 N·m (700 lbf) @ 1,500 rpm
	936F/939F/942F	1,526 N·m (1,126 lbf) @ 1,400 rpm

Bore × Stroke	930F/933F	107 × 124 mm (4.2" × 4.9")
	936F/939F/942F	114 × 145 mm (4.4" × 5.7")

DRIVE AND BRAKES

Description

2-speed axial piston motors with oil disk brakes. Steering controlled by two hand levers with pedals.

Max. travel speed	930F/933F	High: 5.5 km/h (3.4 mph) Low: 3.0 km/h (1.9 mph)
	936F/939F	High: 5.5 km/h (3.4 mph) Low: 3.4 km/h (2.1 mph)

Max. drawbar pull	942F	High: 5.4 km/h (3.4 mph) Low: 2.9 km/h (1.8 mph)
-------------------	-------------	---

Gradeability	35°/70%
--------------	---------

Max. drawbar pull	930F/933F/936F/939F	320 kN (71,939 lbf)
	942F	350 kN (78,683 lbf)

SWING SYSTEM

Description

Planetary gear reduction driven by high torque axial piston motor, with oil disk brake. Swing parking brake resets within five seconds after swing pilot controls return to neutral.

Swing speed	930F/933F	10.3 rpm
	936F/939F	10 rpm
	942F	9.8 rpm

Swing torque	930F/933F	127,000 N·m (93,670 lbf·ft)
	936F/939F/942F	137,000 N·m (101,046 lbf·ft)

UNDERCARRIAGE

Track shoe each side	930F	51
	933F/936F/939F	49
	942F	50

Link pitch /

Shoe width, triple grouser 600 mm (1'12")

Bottom rollers each side 9

Top rollers each side 2

Chain track pitch	930F	203 mm (7.9")
	933F/936F/939F/942F	216 mm (8.5")

SERVICE CAPACITIES

Fuel tank	930F/933F	520 L (137.4 gal)
	936F/939F/942F	620 L (163.8 gal)

Engine oil	930F/933F	23 L (6.1 gal)
	936F/939F/942F	30 L (7.9 gal)

Final drive (each) 2 × 9.5 L (2 × 2.5 gal)

Swing drive 10.5 L (2.8 gal)

Cooling system	930F/933F	35 L (9.2 gal)
	936F/939F/942F	37 L (9.8 gal)

Hydraulic reservoir	930F/933F	195 L (51.5 gal)
	936F/939F/942F	240 L (63.4 gal)

Hydraulic system total	930F/933F	360 L (95.1 gal)
	936F/939F/942F	450 L (118.88 gal)

DEF tank 65 L (17.17 gal)

SOUND PERFORMANCE

Interior Sound Power Level (ISO 6396)	930F/933F/936F/939F	69 dB(A)
	942F	/dB(A)

Exterior Sound Power Level (ISO 6395)	930F/933F/936F/939F	105 dB(A)
	942F	/dB(A)

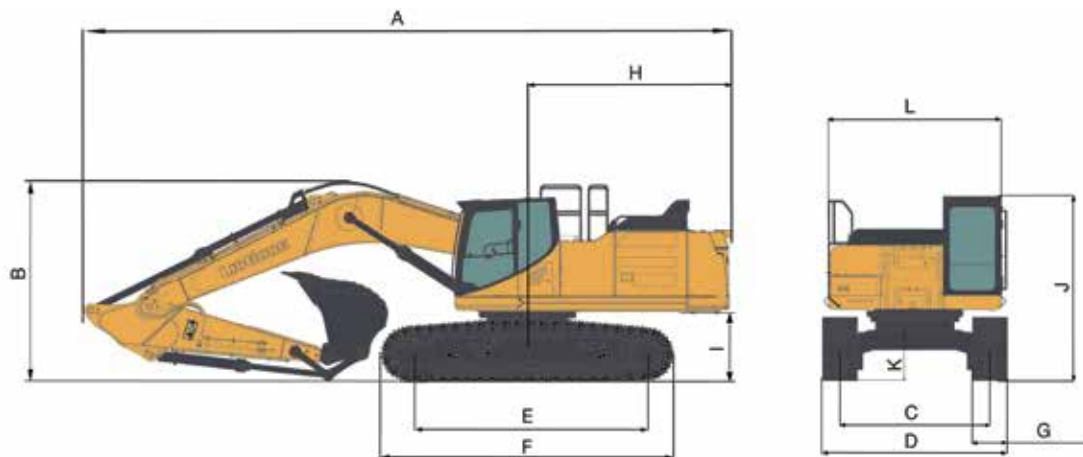

DIMENSIONS	930F/933F	
Boom	6,200 mm (20'4")	
Arm Options	3,050 mm (10'0")	2,600 mm (8'6")
A Shipping Length	930F 10,653 mm (34'11") / 933F 10,650 mm (34'11")	930F 10,250 mm (33'7")
B Shipping Height – Top of Boom	3,525 mm (11'7")	
C Track Gauge	2,590 mm (8'6")	
D Undercarriage Width– 600mm shoes	3,190 mm (10'6")	
E Length to Center of Rollers	930F 4,010 mm (13'2") / 933F 4,140 mm (13'7")	
F Track Length	930F 4,935 mm (16'2") / 933F 5,075 mm (16'8")	
G Track Shoe Width	600 mm (24")	
H Tail Swing Radius	930F 3,233 mm (10'7") / 933F 3,280 mm (10'9")	
I Counterweight Ground Clearance	1,250 mm (4'1")	
J Overall Height of Cab	3,175 mm (10'5")	
Overall Height of Cab-with OPG	3,310 mm (10'10")	
Overall Height of Cab- with dome lamp	3,310 mm (10'10")	
K Min. Ground Clearance	535 mm (1'9")	
L Overall Width of Upper Structure	2,995 mm (9'9") / 3,059 mm (10'0")	

DIMENSIONS	936F	939F	942F
Boom	6,400 mm (21')		
Arm Options	3,200 mm (10'6") / 2,900 mm (9'6") / 2,600 mm (8'6")	3,200 mm (10'6") / 2,900 mm (9'6") / 2,600 mm (8'6")	
A Shipping Length	11,300 mm (37'1")	11,597 mm (37'1")	
B Shipping Height – Top of Boom	3,800 mm (12'6")		
C Track Gauge	2,590 mm (8'6")	2,740 mm (8'6")	
D Undercarriage Width– 600mm shoes	3,190 mm (10'6")	3,400 mm (11'1")	
E Length to Center of Rollers	4,140 mm (13'7")	4,250 mm (13'11")	
F Track Length	5,075 mm (16'8")	5,215 mm (17'1")	
G Track Shoe Width	600 mm (24")		
H Tail Swing Radius	3,593 mm (11'9")	3,766 mm (12'4")	
I Counterweight Ground Clearance	1,250 mm (4'1")		
J Overall Height of Cab	3,175 mm (10'5")		
Overall Height of Cab-with OPG	3,310 mm (10'10")		
Overall Height of Cab- with dome lamp	3,310 mm (10'10")		
K Min. Ground Clearance	545 mm (1'9")		
L Overall Width of Upper Structure	2,995 mm (9'9") / 3,059 mm (10'0")		

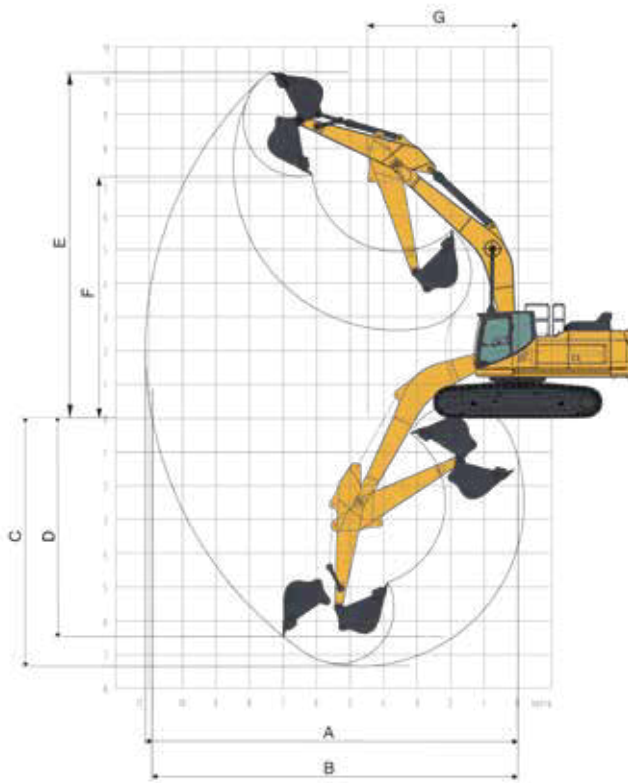

WORKING RANGE	930F/933F		936F/939F/942F		
Boom Length	6,200 mm (20'4")		6,400 mm (21')		
Arm Length	3,050 mm (10'0")	2,600 mm (8'6")	3,200 mm (10'6")	2,900 mm (9'6")	2,600 mm (8'6")
A. Max. Digging Reach	10,653 mm (34'11")	10,250 mm (33'8")	11,100 mm (36'5")	10,728 mm (35'2")	10,560 mm (34'8")
B. Max. Digging Reach on Ground	10,453 mm (34'4")	10,032 mm (32'11")	10,900 mm (35'9")	10,527 mm (34'6")	10,350 mm (33'11")
C. Max. Digging Depth	7,300 mm (23'11")	6,825 mm (22'5")	7,340 mm (24'1")	6,890 mm (22'7")	6,730 mm (22'1")
D. Max. Vertical Wall Digging Depth	6,216 mm (20'5")	5,450 mm (17'11")	6,460 mm (21'2")	5,085 mm (16'8")	4,430 mm (14'6")
E. Max. Cutting Height	10,300 mm (33'10")	10,007 mm (32'10")	10,240 mm (33'7")	9,818 mm (32'3")	9,830 mm (32'3")
F. Max. Dumping Height	7,265 mm (23'10")	7,086 mm (23'3")	7,160 mm (23'6")	6,655 mm (21'10")	6,900 mm (22'8")
G. Min. Front swing radius	4,040 mm (13'3")		4,465 mm (14'8")	4,385 mm (14'5")	4,700 mm (15'5")
Max. Digging Depth, 2.44 m (8') Level	/		/		
Lift above Ground	/		/		
Depth below Ground	/		/		
Bucket Digging Force (ISO)	203 kN (45,636 lbf)		290 kN (65,195 lbf)		
Arm Digging Force (ISO)	149 kN (33,497 lbf)	165 kN (37,093 lbf)	196 kN (44,063 lbf)	227 kN (51,032 lbf)	243 kN (54,629 lbf)
Bucket Capacity	1.4 m ³ (1.8 yd ³)		936F 1.8 m ³ (2.4 yd ³) 939F 2.0 m ³ (2.6 yd ³) 942F 2.1 m ³ (2.7 yd ³)		
Bucket Tip Radius	1,671 mm (5'6")		936F/939F 1,785 mm (5'10") 942F 1,839 mm (6'0")		



MACHINE WEIGHTS AND GROUND PRESSURE 930F

Shoe width	Operating weight	Ground pressure	Overall width
	6.2 m (20'4") boom, 3.05 m (10'0") arm, 1.4 m ³ (1.8 yd ³) bucket, 5,200 kg (11,464 lbs) counterweight		
600 mm (24")	31,600 kg (70,222 lbs)	59.4 kPa (8.6 psi)	3,190 mm (10'5")
700 mm (28")	32,000 kg (70,548 lbs)	52 kPa (7.5 psi)	3,190 mm (10'5")
800 mm (32")	32,400 kg (71,430 lbs)	46 kPa (6.7 psi)	3,190 mm (10'5")
900 mm (35")	32,800 kg (72,312 lbs)	41 kPa (5.9 psi)	3,190 mm (10'5")

MACHINE WEIGHTS AND GROUND PRESSURE 933F

Shoe width	Operating weight	Ground pressure	Overall width
	6.2 m (20'4") boom, 3.05 m (10'0") arm, 1.4 m ³ (1.8 yd ³) bucket, 6,700 kg (14,771 lbs) counterweight		
600 mm (24")	34,300 kg (75,619 lbs)	62.7 kPa (9.1 psi)	3,190 mm (10'5")
700 mm (28")	34,700 kg (76,500 lbs)	54 kPa (7.8 psi)	3,190 mm (10'5")
800 mm (32")	35,100 kg (77,382 lbs)	48 kPa (7.0 psi)	3,190 mm (10'5")
900 mm (35")	35,500 kg (78,264 lbs)	43 kPa (6.2 psi)	3,190 mm (10'5")

MACHINE WEIGHTS AND GROUND PRESSURE 936F

Shoe width	Operating weight	Ground pressure	Overall width
	6.4 m (21') boom, 3.2 m (10'6") arm, 1.8 m ³ (2.35 yd ³) bucket, 7,700 kg (16,976 lbs) counterweight		
600 mm (24")	38,800 kg (85,539 lbs)	69.7 kPa (10.1 psi)	3,190 mm (10'5")
700 mm (28")	39,200 kg (86,421 lbs)	60.4 kPa (8.8 psi)	3,190 mm (10'5")
800 mm (32")	39,600 kg (87,303 lbs)	53.4 kPa (7.7 psi)	3,190 mm (10'5")
900 mm (35")	40,000 kg (88,184 lbs)	47.9 kPa (6.9 psi)	3,190 mm (10'5")

MACHINE WEIGHTS AND GROUND PRESSURE 939F

Shoe width	Operating weight	Ground pressure	Overall width
	6.4 m (21') boom, 3.2 m (10'6") arm, 1.8 m ³ (2.35 yd ³) bucket, 8,500 kg (18,739 lbs) counterweight		
600 mm (24")	39,800 kg (87,744 lbs)	71.5 kPa (10.4 psi)	3,190 mm (10'5")
700 mm (28")	40,200 kg (88,626 lbs)	61.9 kPa (9.0 psi)	3,190 mm (10'5")
800 mm (32")	40,600 kg (89,508 lbs)	54.7 kPa (7.9 psi)	3,190 mm (10'5")
900 mm (35")	41,000 kg (90,390 lbs)	49.1 kPa (7.1 psi)	3,190 mm (10'5")

MACHINE WEIGHTS AND GROUND PRESSURE 942F

Shoe width	Operating weight	Ground pressure	Overall width
	6.4 m (21') boom, 3.2 m (10'6") arm, 2.1 m ³ (2.75 yd ³) bucket, 9,000 kg (19,842 lbs) counterweight		
600 mm (24")	42,800 kg (94,358 lbs)	76.3 kPa (11.1 psi)	3,190 mm (10'5")
700 mm (28")	43,200 kg (95,240 lbs)	66.0 kPa (9.6 psi)	3,190 mm (10'5")
800 mm (32")	43,600 kg (96,122 lbs)	58.3 kPa (8.5 psi)	3,190 mm (10'5")
900 mm (35")	44,000 kg (97,003 lbs)	52.3 kPa (7.6 psi)	3,190 mm (10'5")

ARM DIMENSIONS

	930F/933F		936F/939F/942F		
Arm	3,050 mm (10'0")	2,600 mm (8'6")	3,200 mm (10'6")	2,900 mm (9'6")	2,600 mm (8'6")
Length	4,224 mm (13'10")	3,800 mm (12'6")	4,384 mm (14'5")	4,166 mm (13'8")	3,818 mm (12'6")
Height	1,016 mm (3'4")	4,045 mm (13'3")	1,095 mm (3'7")	1,107 mm (3'8")	1,120 mm (3'8")
Width	532 mm (1'9")	532 mm (1'9")	655 mm (2'2")	655 mm (2'2")	655 mm (2'2")
Weight	930F 1,720 kg (3,792 lbs) 933F 1,834 kg (4,043 lbs)	1,752 kg (3,862 lbs)	2,189.5 kg (4,827 lbs)	2,157 kg (4,755 lbs)	2,046.5 kg (4,512 lbs)

Cylinder, linkage and pin included.

BOOM DIMENSIONS

	930F/933F	936F/939F/942F
Boom	6,200 mm (20'4")	6,400 mm (21')
Length	6,430 mm (21'1")	6,640 mm (21'9")
Height	1,557 mm (5'1")	1,684 mm (5'6")
Width	942 mm (3'1")	973 mm (3'2")
Weight	930F 2,839 kg (6,259 lbs) / 933F 3,034 kg (6,689 lbs)	3,535.5 kg (7,794 lbs)

Cylinder, piping and pin included. Boom cylinder pin excluded.

BUCKET SELECTION GUIDE 930F/933F

Bucket type	Capacity	Cutting width	Weight	Teeth pcs	6.2 m (20'4") Boom	
					3.05 m (10'0") Arm	2.6 m (8'6") Arm
Earth type	/	/	/	/	/	/
General type	1.4 m ³ (1.83 yd ³)	1,445 mm (4'9")	1,387 kg (3,058 lbs)	5	C&D	/
General type	1.6 m ³ (2.09 yd ³)	1,560 mm (5'1")	1,487.5 kg (3,279 lbs)	5	/	C&D
Rock type	/	/	/	/	/	/

The recommendations are given as a guide only, based on typical operation conditions.
Bucket capacity based on ISO 7451, heaped material with a 1:1 angle of repose.

Maximum material density:

- A. 1,200-1,300 kg/m³ (2,023-2,191 lb/yd³): Coal, Caliche, Shale
- B. 1,400-1,600 kg/m³ (2,360-2,697 lb/yd³): Wet earth and clay, limestone, sandstone
- C. 1,700-1,800 kg/m³ (2,865-3,034 lb/yd³): Granite, wet sand, well blasted rock
- D. 1,900 kg/m³ (3,203 lb/yd³): Wet mud, Iron ore
- NA. Not applicable

BUCKET SELECTION GUIDE 936F

Bucket type	Capacity	Cutting width	Weight	Teeth pcs	6.2 m (20'4") Boom		
					3.2 m (10'5") Arm	2.9 m (9'6") Arm	2.6 m (8'6") Arm
Earth type	/	/	/	/	/	/	/
General type	1.8 m ³ (2.35 yd ³)	1,540 mm (5'0")	1,667 kg (3,675 lbs)	5	B	C	D
Rock type	/	/	/	/	/	/	/

The recommendations are given as a guide only, based on typical operation conditions.
Bucket capacity based on ISO 7451, heaped material with a 1:1 angle of repose.

Maximum material density:

- A. 1,200-1,300 kg/m³ (2,023-2,191 lb/yd³): Coal, Caliche, Shale
- B. 1,400-1,600 kg/m³ (2,360-2,697 lb/yd³): Wet earth and clay, limestone, sandstone
- C. 1,700-1,800 kg/m³ (2,865-3,034 lb/yd³): Granite, wet sand, well blasted rock
- D. 1,900 kg/m³ (3,203 lb/yd³): Wet mud, Iron ore
- NA. Not applicable

BUCKET SELECTION GUIDE 939F/942F

Bucket type	Capacity	Cutting width	Weight	Teeth pcs	6.2 m (20'4") Boom		
					3.2 m (10'5") Arm	2.9 m (9'6") Arm	2.6 m (8'6") Arm
Earth type	/	/	/	/	/	/	/
General type	939F 2.0 m ³ (2.62 yd ³) 942F 2.1 m ³ (2.75 yd ³)	1,605 mm (5'3")	1,736 kg (3,827 lbs)	5	B	C	D
Rock type	/	/	/	/	/	/	/

The recommendations are given as a guide only, based on typical operation conditions.
Bucket capacity based on ISO 7451, heaped material with a 1:1 angle of repose.

Maximum material density:

- A. 1,200-1,300 kg/m³ (2,023-2,191 lb/yd³): Coal, Caliche, Shale
- B. 1,400-1,600 kg/m³ (2,360-2,697 lb/yd³): Wet earth and clay, limestone, sandstone
- C. 1,700-1,800 kg/m³ (2,865-3,034 lb/yd³): Granite, wet sand, well blasted rock
- D. 1,900 kg/m³ (3,203 lb/yd³): Wet mud, Iron ore
- NA. Not applicable

Lifting capacity at the arm end without bucket.
For lifting capacity including bucket, weight of the bucket or the bucket with quick coupler must be deducted from the lifting capacities.
Lifting capacities are based on the machine standing on a firm, uniform supporting surface.



Rating over-front (Cf)



Rating over-side (Cs)

- Do not attempt to lift or hold any load that is greater than these rated values at their specified load radius and height. Weight of all accessories must be deducted from the above lifting capacities.
- The rated loads are in compliance with ISO 10567 Hydraulic Excavator Lift Capacity Rating Standard. They do not exceed 87% of hydraulic lifting capacity or 75% tipping load.
- Ratings at bucket lift hook.
- Lifting capacities are based on machine standing on level, firm and uniform ground.
- *Indicates the load is limited by hydraulic capacity rather than tipping capacity.
- Operator should be fully acquainted with the Operator's and Maintenance Instructions before operating this machine and rules for the safe operation of equipment should be adhered to at all times.

LIFTING CAPACITY

930F with 600 mm (24") Shoes, 6,200 mm (20'4") Boom, 3,050 mm (10'0") Arm

Conditions

A: Load radius
B: Load point height
C: Lifting capacity rating
Cf: Rating loads over front
Cs: Rating loads over side or 360°

Boom length: 6,200 mm (20'4")
Arm length: 3,050 mm (10'0")
Shoes: 600 mm (24")
Bucket: None
Unit: kg



A (Unit: m)

B (m)	1.5		3		4.5		6		7.5		MAX REACH		A (m)	
	Cf	Cs	Cf	Cs	Cf	Cs	Cf	Cs	Cf	Cs	Cf	Cs		
6.0 (20 ft)	kg						*6,977	*6,977	*6,852	*6,852	*6,154	6,142	8.1	
	lb						*15,382	*15,382	*15,107	*15,107	*13,568	13,541	27.0	
4.5 (15 ft)	kg				*9,600	*9,600	*8,032	*8,032	*7,291	6,787	*6,045	5,464	8.7	
	lb				*21,164	*21,164	*17,708	*17,708	*16,075	14,962	*13,326	12,046	29.0	
3.0 (10 ft)	kg				*12,491	*12,491	*9,402	8,928	*7,980	6,602	*6,197	5,130	9.0	
	lb				*27,539	*27,539	*20,727	19,682	*17,594	14,554	*13,662	11,310	30.0	
1.5 (5 ft)	kg				*14,790	12,596	*10,677	8,589	*8,682	6,423	*6,981	5,058	9.0	
	lb				*32,607	27,770	*23,540	18,936	*19,141	14,161	*15,392	11,151	30.0	
GROUND LEVEL	kg				*15,796	12,320	*11,514	8,377	*9,186	6,299	*7,505	5,157	8.8	
	lb				*34,825	27,162	*25,383	18,467	*20,251	13,887	*16,547	11,369	29.0	
-1.5 (-5 ft)	kg	*8,654	*8,654	*12,956	*12,956	*15,766	12,284	*11,748	8,302	*9,291	6,258	*8,257	5,540	8.3
	lb	*19,079	*19,079	*28,563	*28,563	*34,757	27,082	*25,899	18,303	*20,482	13,797	*18,203	12,215	27.0
-3.0 (-10 ft)	kg	*15,061	*15,061	*20,740	*20,740	*14,851	12,404	*11,236	8,360		*8,582	6,344	7.5	
	lb	*33,203	*33,203	*45,724	*45,724	*32,741	27,347	*24,772	18,430		*18,921	13,987	25.0	
-4.5 (-15 ft)	kg			*17,371	*17,371	*12,713	12,692	*9,348	8,600		*8,879	8,262	6.2	
	lb			*38,297	*38,297	*28,027	27,981	*20,610	18,959		*19,575	18,215	20.0	

LIFTING CAPACITY

930F with 700 mm (28") Shoes, 6,200 mm (20'4") Boom, 3,050 mm (10'0") Arm

Conditions

A: Load radius
B: Load point height
C: Lifting capacity rating
Cf: Rating loads over front
Cs: Rating loads over side or 360°

Boom length: 6,200 mm (20'4")
Arm length: 3,050 mm (10'0")
Shoes: 700 mm (28")
Bucket: None
Unit: kg

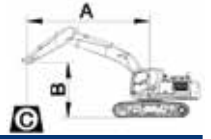

B (m)		A (Unit: m)												A (m)
		1.5		3		4.5		6		7.5		MAX REACH		
		Cf	Cs	Cf	Cs	Cf	Cs	Cf	Cs	Cf	Cs	Cf	Cs	
6.0 (20 ft)	kg							*6,977	*6,977	*6,852	*6,852	*6,154	*6,154	8.1
	lb							*15,382	*15,382	*15,107	*15,107	*13,568	*13,568	27.0
4.5 (15 ft)	kg					*9,600	*9,600	*8,032	*8,032	*7,291	6,905	*6,045	5,563	8.7
	lb					*21,164	*21,164	*17,708	*17,708	*16,075	15,223	*13,326	12,264	29.0
3.0 (10 ft)	kg					*12,491	*12,491	*9,402	9,083	*7,980	6,720	*6,197	5,225	9.0
	lb					*27,539	*27,539	*20,727	20,026	*17,594	14,815	*13,662	11,520	30.0
1.5 (5 ft)	kg					*14,790	12,825	*10,677	8,745	*8,682	6,542	*6,981	5,153	9.0
	lb					*32,607	28,275	*23,540	19,280	*19,141	14,422	*15,392	11,361	30.0
GROUND LEVEL	kg					*15,796	12,549	*11,514	8,532	*9,186	6,417	*7,505	5,255	8.8
	lb					*34,825	27,666	*25,383	18,811	*20,251	14,147	*16,547	11,585	29.0
-1.5 (-5 ft)	kg	*8,654	*8,654	*12,956	*12,956	*15,766	12,513	*11,748	8,458	*9,291	6,376	*8,257	5,645	8.3
	lb	*19,079	*19,079	*28,563	*28,563	*34,757	27,587	*25,899	18,647	*20,482	14,057	*18,203	12,445	27.0
-3.0 (-10 ft)	kg	*15,061	*15,061	*20,740	*20,740	*14,851	12,633	*11,236	8,515			*8,582	6,463	7.5
	lb	*33,203	*33,203	*45,724	*45,724	*32,741	27,851	*24,772	18,773			*18,921	14,248	25.0
-4.5 (-15 ft)	kg			*17,371	*17,371	*12,713	*12,713	*9,348	8,756			*8,879	8,412	6.2
	lb			*38,297	*38,297	*28,027	*28,027	*20,610	19,303			*19,575	18,544	20.0

LIFTING CAPACITY

930F with 600 mm (24") Shoes, 6,200 mm (20'4") Boom, 2,600 mm (8'6") Arm

Conditions

A: Load radius
B: Load point height
C: Lifting capacity rating
Cf: Rating loads over front
Cs: Rating loads over side or 360°

Boom length: 6,200 mm (20'4")
Arm length: 2,600 mm (8'6")
Shoes: 600 mm (24")
Bucket: None
Unit: kg

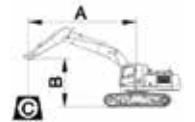

B (m)		A (Unit: m)										A (m)
		3		4.5		6		7.5		MAX REACH		
		Cf	Cs	Cf	Cs	Cf	Cs	Cf	Cs	Cf	Cs	
6.0 (20 ft)	kg					*7,558	*7,558	*7,388	6,842	*7,407	6,702	7.6
	lb					*16,661	*16,661	*16,289	15,084	*16,330	14,775	25.0
4.5 (15 ft)	kg			*10,492	*10,492	*8,557	*8,557	*7,700	6,737	*7,551	5,920	8.2
	lb			*23,131	*23,131	*18,864	*18,864	*16,976	14,852	*16,646	13,052	27.0
3.0 (10 ft)	kg			*13,310	12,974	*9,844	8,829	*8,307	6,562	*7,277	5,446	8.6
	lb			*29,343	28,604	*21,703	19,465	*18,314	14,467	*16,044	12,007	28.0
1.5 (5 ft)	kg			*15,261	12,404	*10,985	8,511	*8,916	6,398	*8,031	5,369	8.6
	lb			*33,645	27,345	*24,218	18,763	*19,657	14,106	*17,706	11,836	28.0
GROUND LEVEL	kg			*15,836	12,229	*11,644	8,333	*9,299	6,296	*8,319	5,485	8.4
	lb			*34,912	26,959	*25,671	18,371	*20,501	13,881	*18,341	12,093	28.0
-1.5 (-5 ft)	kg	*13,578	*13,578	*15,485	12,261	*11,677	8,299	*9,212	6,292	*8,777	6,012	7.8
	lb	*29,934	*29,934	*34,139	27,031	*25,743	18,297	*20,308	13,872	*19,350	13,254	26.0
-3.0 (-10 ft)	kg	*19,284	*19,284	*14,277	12,439	*10,883	8,410			*9,182	7,088	6.9
	lb	*42,515	*42,515	*31,475	27,424	*23,992	18,540			*20,243	15,626	23.0
-4.5 (-15 ft)	kg	*15,525	*15,525	*11,627	*11,627					*9,318	*9,318	5.5
	lb	*34,226	*34,226	*25,634	*25,634					*20,543	*20,543	18.0



LIFTING CAPACITY

930F with 700 (28") mm Shoes, 6,200 mm (20'4") Boom, 2,600 mm (8'6") Arm

Conditions

Boom length: 6,200 mm (20'4")
 Arm length: 2,600 mm (8'6")
 Shoes: 700 mm (28")
 Bucket: None
 Unit: kg

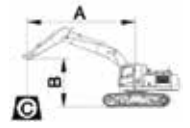

A (Unit: m)

B (m)	A (Unit: m)												A (m)
	3		4.5		6		7.5		MAX REACH		Cf	Cs	
	Cf	Cs	Cf	Cs	Cf	Cs	Cf	Cs	Cf	Cs			Cf
6.0 (20 ft)	kg					*7,558	*7,558	*7,388	6,960	*7,407	6,818	7.6	
	lb					*16,661	*16,661	*16,289	15,344	*16,330	15,032	25.0	
4.5 (15 ft)	kg			*10,492	*10,492	*8,557	*8,557	*7,700	6,855	*7,551	6,027	8.2	
	lb			*23,131	*23,131	*18,864	*18,864	*16,976	15,113	*16,646	13,286	27.0	
3.0 (10 ft)	kg			*13,310	13,203	*9,844	8,985	*8,307	6,680	*7,277	5,547	8.6	
	lb			*29,343	29,108	*21,703	19,809	*18,314	14,728	*16,044	12,228	28.0	
1.5 (5 ft)	kg			*15,261	12,633	*10,985	8,667	*8,916	6,516	*8,031	5,469	8.6	
	lb			*33,645	27,850	*24,218	19,107	*19,657	14,366	*17,706	12,057	28.0	
GROUND LEVEL	kg			*15,836	12,457	*11,644	8,489	*9,299	6,414	*8,319	5,589	8.4	
	lb			*34,912	27,464	*25,671	18,714	*20,501	14,141	*18,341	12,321	28.0	
-1.5 (-5 ft)	kg	*13,578	*13,578	*15,485	12,490	*11,677	8,455	*9,212	6,410	*8,777	6,125	7.8	
	lb	*29,934	*29,934	*34,139	27,535	*25,743	18,640	*20,308	14,132	*19,350	13,503	26.0	
-3.0 (-10 ft)	kg	*19,284	*19,284	*14,277	12,668	*10,883	8,566			*9,182	7,219	6.9	
	lb	*42,515	*42,515	*31,475	27,929	*23,992	18,884			*20,243	15,914	23.0	
-4.5 (-15 ft)	kg	*15,525	*15,525	*11,627	*11,627					*9,318	*9,318	5.5	
	lb	*34,226	*34,226	*25,634	*25,634					*20,543	*20,543	18.0	

LIFTING CAPACITY

933F with 600 mm (24") Shoes, 6,200 mm (20'4") Boom, 3,050 mm (10'0") Arm

Conditions

Boom length: 6,200 mm (20'4")
 Arm length: 3,050 mm (10'0")
 Shoes: 600 mm (24")
 Bucket: None
 Unit: kg

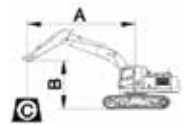

A (Unit: m)

B (m)	A (Unit: m)												A (m)	
	1.5		3		4.5		6		7.5		MAX REACH			
	Cf	Cs	Cf	Cs	Cf	Cs	Cf	Cs	Cf	Cs	Cf	Cs		
6.0 (20 ft)	kg						*6,977	*6,977	*6,852	*6,852	*6,154	*6,154	8.1	
	lb						*15,382	*15,382	*15,107	*15,107	*13,568	*13,568	27.0	
4.5 (15 ft)	kg				*9,600	*9,600	*8,032	*8,032	*7,291	7,230	*6,045	5,835	8.7	
	lb				*21,164	*21,164	*17,708	*17,708	*16,075	15,939	*13,326	12,864	29.0	
3.0 (10 ft)	kg				*12,491	*12,491	*9,402	*9,402	*7,980	7,045	*6,197	5,487	9.0	
	lb				*27,539	*27,539	*20,727	*20,727	*17,594	15,532	*13,662	12,097	30.0	
1.5 (5 ft)	kg				*14,790	13,455	*10,677	9,174	*8,682	6,867	*6,981	5,415	9.0	
	lb				*32,607	29,662	*23,540	20,225	*19,141	15,139	*15,392	11,938	30.0	
GROUND LEVEL	kg				*15,796	13,179	*11,514	8,961	*9,186	6,742	*7,505	5,523	8.8	
	lb				*34,825	29,054	*25,383	19,756	*20,251	14,864	*16,547	12,177	29.0	
-1.5 (-5 ft)	kg	*8,654	*8,654	*12,956	*12,956	*15,766	13,143	*11,748	8,887	*9,291	6,701	*8,257	5,933	8.3
	lb	*19,079	*19,079	*28,563	*28,563	*34,757	28,974	*25,899	19,592	*20,482	14,774	*18,203	13,080	27.0
-3.0 (-10 ft)	kg	*15,061	*15,061	*20,740	*20,740	*14,851	13,262	*11,236	8,944		*8,582	6,788	7.5	
	lb	*33,203	*33,203	*45,724	*45,724	*32,741	29,239	*24,772	19,718		*18,921	14,964	25.0	
-4.5 (-15 ft)	kg			*17,371	*17,371	*12,713	*12,713	*9,348	9,184		*8,879	8,823	6.2	
	lb			*38,297	*38,297	*28,027	*28,027	*20,610	20,248		*19,575	19,451	20.0	

LIFTING CAPACITY

933F with 700 mm (28") Shoes, 6,200 mm (20'4") Boom, 3,050 mm (10'0") Arm

Conditions

A: Load radius
 B: Load point height
 C: Lifting capacity rating
 Cf: Rating loads over front
 Cs: Rating loads over side or 360°

Boom length: 6,200 mm (20'4")
 Arm length: 3,050 mm (10'0")
 Shoes: 700 mm (28")
 Bucket: None
 Unit: kg

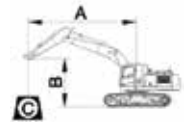

B (m)	A (Unit: m)														A (m)
	1.5		3		4.5		6		7.5		MAX REACH		Cf	Cs	
	Cf	Cs	Cf	Cs	Cf	Cs	Cf	Cs	Cf	Cs	Cf	Cs			
6.0 (20 ft)	kg							*6,977	*6,977	*6,852	*6,852	*6,154	*6,154	8.1	
	lb							*15,382	*15,382	*15,107	*15,107	*13,568	*13,568	27.0	
4.5 (15 ft)	kg					*9,600	*9,600	*8,032	*8,032	*7,291	*7,291	*6,045	5,934	8.7	
	lb					*21,164	*21,164	*17,708	*17,708	*16,075	*16,075	*13,326	13,083	29.0	
3.0 (10 ft)	kg					*12,491	*12,491	*9,402	*9,402	*7,980	7,163	*6,197	5,582	9.0	
	lb					*27,539	*27,539	*20,727	*20,727	*17,594	15,792	*13,662	12,307	30.0	
1.5 (5 ft)	kg					*14,790	13,683	*10,677	9,330	*8,682	6,985	*6,981	5,510	9.0	
	lb					*32,607	30,167	*23,540	20,569	*19,141	15,399	*15,392	12,148	30.0	
GROUND LEVEL	kg					*15,796	13,407	*11,514	9,117	*9,186	6,860	*7,505	5,621	8.8	
	lb					*34,825	29,558	*25,383	20,100	*20,251	15,125	*16,547	12,393	29.0	
-1.5 (-5 ft)	kg	*8,654	*8,654	*12,956	*12,956	*15,766	13,371	*11,748	9,043	*9,291	6,820	*8,257	6,038	8.3	
	lb	*19,079	*19,079	*28,563	*28,563	*34,757	29,479	*25,899	19,936	*20,482	15,034	*18,203	13,311	27.0	
-3.0 (-10 ft)	kg	*15,061	*15,061	*20,740	*20,740	*14,851	13,491	*11,236	9,100			*8,582	6,906	7.5	
	lb	*33,203	*33,203	*45,724	*45,724	*32,741	29,743	*24,772	20,062			*18,921	15,225	25.0	
-4.5 (-15 ft)	kg			*17,371	*17,371	*12,713	*12,713	*9,348	9,340			*8,879	*8,879	6.2	
	lb			*38,297	*38,297	*28,027	*28,027	*20,610	20,592			*19,575	*19,575	20.0	

LIFTING CAPACITY

933F with 600 mm (24") Shoes, 6,200 mm (20'4") Boom, 2,600 mm (8'6") Arm

Conditions

A: Load radius
 B: Load point height
 C: Lifting capacity rating
 Cf: Rating loads over front
 Cs: Rating loads over side or 360°

Boom length: 6,200 mm (20'4")
 Arm length: 2,600 mm (8'6")
 Shoes: 600 mm (24")
 Bucket: None
 Unit: kg

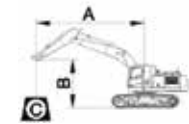

B (m)	A (Unit: m)												A (m)	
	3		4.5		6		7.5		MAX REACH		Cf	Cs		
	Cf	Cs	Cf	Cs	Cf	Cs	Cf	Cs	Cf	Cs				
6.0 (20 ft)	kg					*7,558	*7,558	*7,388	7,285	*7,407	7,138			7.6
	lb					*16,661	*16,661	*16,289	16,061	*16,330	15,737			25.0
4.5 (15 ft)	kg			*10,492	*10,492	*8,557	*8,557	*7,700	7,180	*7,551	6,319			8.2
	lb			*23,131	*23,131	*18,864	*18,864	*16,976	15,829	*16,646	13,930			27.0
3.0 (10 ft)	kg			*13,310	*13,310	*9,844	9,414	*8,307	7,006	*7,277	5,823			8.6
	lb			*29,343	*29,343	*21,703	20,754	*18,314	15,445	*16,044	12,837			28.0
1.5 (5 ft)	kg			*15,261	13,262	*10,985	9,095	*8,916	6,842	*8,031	5,745			8.6
	lb			*33,645	29,238	*24,218	20,052	*19,657	15,083	*17,706	12,666			28.0
GROUND LEVEL	kg			*15,836	13,087	*11,644	8,917	*9,299	6,740	*8,319	5,872			8.4
	lb			*34,912	28,851	*25,671	19,659	*20,501	14,858	*18,341	12,947			28.0
-1.5 (-5 ft)	kg	*13,578	*13,578	*15,485	13,119	*11,677	8,884	*9,212	6,735	*8,777	6,435			7.8
	lb	*29,934	*29,934	*34,139	28,923	*25,743	19,585	*20,308	14,849	*19,350	14,186			26.0
-3.0 (-10 ft)	kg	*19,284	*19,284	*14,277	13,298	*10,883	8,994			*9,182	7,579			6.9
	lb	*42,515	*42,515	*31,475	29,316	*23,992	19,829			*20,243	16,708			23.0
-4.5 (-15 ft)	kg	*15,525	*15,525	*11,627	*11,627					*9,318	*9,318			5.5
	lb	*34,226	*34,226	*25,634	*25,634					*20,543	*20,543			18.0



LIFTING CAPACITY

933F with 700 mm (28") Shoes, 6,200 mm (20'4") Boom, 2,600 (8'6") mm Arm

A: Load radius
 B: Load point height
 C: Lifting capacity rating
 Cf: Rating loads over front
 Cs: Rating loads over side or 360°

Conditions

Boom length: 6,200 mm (20'4")
 Arm length: 2,600 mm (8'6")
 Shoes: 700 mm (28")
 Bucket: None
 Unit: kg



A (Unit: m)

B (m)	A (Unit: m)												A (m)
	3		4.5		6		7.5		MAX REACH		Cf	Cs	
	Cf	Cs	Cf	Cs	Cf	Cs	Cf	Cs	Cf	Cs			Cf
6.0 (20 ft)	kg					*7,558	*7,558	*7,388	*7,388	*7,407	7,254		7.6
	lb					*16,661	*16,661	*16,289	*16,289	*16,330	15,993		25.0
4.5 (15 ft)	kg			*10,492	*10,492	*8,557	*8,557	*7,700	7,298	*7,551	6,425		8.2
	lb			*23,131	*23,131	*18,864	*18,864	*16,976	16,090	*16,646	14,164		27.0
3.0 (10 ft)	kg			*13,310	*13,310	*9,844	9,570	*8,307	7,124	*7,277	5,923		8.6
	lb			*29,343	*29,343	*21,703	21,098	*18,314	15,705	*16,044	13,058		28.0
1.5 (5 ft)	kg			*15,261	13,491	*10,985	9,251	*8,916	6,960	*8,031	5,846		8.6
	lb			*33,645	29,742	*24,218	20,396	*19,657	15,344	*17,706	12,887		28.0
GROUND LEVEL	kg			*15,836	13,316	*11,644	9,073	*9,299	6,858	*8,319	5,976		8.4
	lb			*34,912	29,356	*25,671	20,003	*20,501	15,119	*18,341	13,174		28.0
-1.5 (-5 ft)	kg	*13,578	*13,578	*15,485	13,348	*11,677	9,040	*9,212	6,854	*8,777	6,548		7.8
	lb	*29,934	*29,934	*34,139	29,427	*25,743	19,929	*20,308	15,110	*19,350	14,435		26.0
-3.0 (-10 ft)	kg	*19,284	*19,284	*14,277	13,526	*10,883	9,150			*9,182	7,709		6.9
	lb	*42,515	*42,515	*31,475	29,821	*23,992	20,173			*20,243	16,996		23.0
-4.5 (-15 ft)	kg	*15,525	*15,525	*11,627	*11,627					*9,318	*9,318		5.5
	lb	*34,226	*34,226	*25,634	*25,634					*20,543	*20,543		18.0

LIFTING CAPACITY

936F with 600 mm (24") Shoes, 6,400 mm (21') Boom, 3,200 mm (10'6") Arm

A: Load radius
 B: Load point height
 C: Lifting capacity rating
 Cf: Rating loads over front
 Cs: Rating loads over side or 360°

Conditions

Boom length: 6,400 mm (21')
 Arm length: 3,200 mm (10'6")
 Shoes: 600 mm (24")
 Bucket: None
 Unit: kg

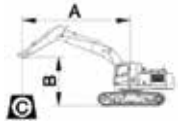

A (Unit: m)

B (m)	A (Unit: m)												A (m)	
	3		4.5		6		7.5		9		MAX REACH			Cf
	Cf	Cs	Cf	Cs	Cf	Cs	Cf	Cs	Cf	Cs	Cf	Cs		
6.0 (20 ft)	kg						*8,170	6,832			*7,295	5,565	8.5	
	lb						*18,012	15,061			*16,082	12,269	28.0	
4.5 (15 ft)	kg				*9,921	9,196	*8,711	6,626	*7,866	5,001	*6,900	4,910	9.1	
	lb				*21,871	20,273	*19,204	14,608	*17,343	11,025	*15,212	10,824	30.0	
3.0 (10 ft)	kg			*15,350	12,859	*11,374	8,662	*9,449	6,359	8,297	4,891	7,894	4,655	9.3
	lb			*33,841	28,349	*25,076	19,095	*20,831	14,019	18,292	10,784	17,403	10,262	31.0
1.5 (5 ft)	kg			*17,566	11,989	*12,641	8,197	*10,145	6,106	8,162	4,770	7,668	4,491	9.4
	lb			*38,727	26,431	*27,869	18,071	*22,365	13,462	17,995	10,517	16,906	9,901	31.0
GROUND LEVEL	kg			*18,247	11,632	*13,353	7,906	10,421	5,927	8,072	4,689	7,836	4,562	9.2
	lb			*40,228	25,644	*29,438	17,429	22,975	13,067	17,796	10,338	17,275	10,057	30.0
-1.5 (-5 ft)	kg	*15,064	*15,064	*17,779	11,584	*13,353	7,797	10,338	5,855		8,445	4,886	8.7	
	lb	*33,210	*33,210	*39,197	25,538	*29,438	17,190	22,792	12,908		18,619	10,773	29.0	
-3.0 (-10 ft)	kg	*22,032	*22,032	*16,332	11,727	*12,505	7,853	*9,673	5,921		*8,909	5,578	7.9	
	lb	*48,573	*48,573	*36,005	25,854	*27,569	17,312	*21,326	13,054		*19,641	12,297	26.0	
-4.5 (-15 ft)	kg	*17,734	*17,734	*13,554	12,064	*10,284	8,103				*8,699	7,077	6.7	
	lb	*39,098	*39,098	*29,882	26,596	*22,673	17,864				*19,177	15,602	22.0	

LIFTING CAPACITY

936F with 700 mm (28") Shoes, 6,400 mm (21') Boom, 3,200 mm (10'6") Arm

Conditions

A: Load radius
 B: Load point height
 C: Lifting capacity rating
 Cf: Rating loads over front
 Cs: Rating loads over side or 360°

Boom length: 6,400 mm (21')
 Arm length: 3,200 mm (10'6")
 Shoes: 700 mm (28")
 Bucket: None
 Unit: kg

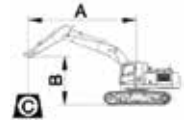

A (Unit: m)

B (m)		3		4.5		6		7.5		9		MAX REACH		A (m)
		Cf	Cs	Cf	Cs	Cf	Cs	Cf	Cs	Cf	Cs	Cf	Cs	
6.0 (20 ft)	kg							*8,170	6,940			*7,295	5,658	8.5
	lb							*18,012	15,299			*16,082	12,473	28.0
4.5 (15 ft)	kg					*9,921	9,338	*8,711	6,734	*7,866	5,088	*6,900	4,995	9.1
	lb					*21,871	20,586	*19,204	14,846	*17,343	11,217	*15,212	11,013	30.0
3.0 (10 ft)	kg			*15,350	13,067	*11,374	8,804	*9,449	6,467	*8,377	4,978	8,018	4,739	9.3
	lb			*33,841	28,809	*25,076	19,409	*20,831	14,256	*18,467	10,975	17,678	10,447	31.0
1.5 (5 ft)	kg			*17,566	12,198	*12,641	8,339	*10,145	6,214	8,292	4,857	*7,724	4,573	9.4
	lb			*38,727	26,891	*27,869	18,385	*22,365	13,699	18,281	10,708	*17,029	10,083	31.0
GROUND LEVEL	kg			*18,247	11,841	*13,353	8,048	*10,575	6,035	8,202	4,776	7,962	4,646	9.2
	lb			*40,228	26,104	*29,438	17,743	*23,313	13,305	18,083	10,530	17,553	10,243	30.0
-1.5 (-5 ft)	kg	*15,064	*15,064	*17,779	11,793	*13,353	7,939	10,504	5,963			8,581	4,977	8.7
	lb	*33,210	*33,210	*39,197	25,999	*29,438	17,503	23,158	13,145			18,919	10,972	29.0
-3.0 (-10 ft)	kg	*22,032	*22,032	*16,332	11,936	*12,505	7,995	*9,673	6,029			*8,909	5,679	7.9
	lb	*48,573	*48,573	*36,005	26,314	*27,569	17,626	*21,326	13,291			*19,641	12,520	26.0
-4.5 (-15 ft)	kg	*17,734	*17,734	*13,554	12,272	*10,284	8,245					*8,699	7,201	6.7
	lb	*39,098	*39,098	*29,882	27,056	*22,673	18,177					*19,177	15,875	22.0

LIFTING CAPACITY

936F with 600 mm (24") Shoes, 6,400 mm (21') Boom, 2,900 mm (9'6") Arm

Conditions

A: Load radius
 B: Load point height
 C: Lifting capacity rating
 Cf: Rating loads over front
 Cs: Rating loads over side or 360°

Boom length: 6,400 mm (21')
 Arm length: 2,900 mm (9'6")
 Shoes: 600 mm (24")
 Bucket: None
 Unit: kg



A (Unit: m)

B (m)		3		4.5		6		7.5		9		MAX REACH		A (m)
		Cf	Cs	Cf	Cs	Cf	Cs	Cf	Cs	Cf	Cs	Cf	Cs	
6.0 (20 ft)	kg							*8,501	6,777			*8,156	5,853	8.2
	lb							*18,740	14,940			*17,981	12,904	27.0
4.5 (15 ft)	kg			*12,911	*12,911	*10,290	9,103	*8,982	6,581			*7,922	5,147	8.8
	lb			*28,464	*28,464	*22,686	20,070	*19,802	14,508			*17,465	11,348	29.0
3.0 (10 ft)	kg			*15,911	12,609	*11,677	8,568	*9,664	6,319	8,275	4,872	*8,051	4,791	9.1
	lb			*35,077	27,797	*25,743	18,889	*21,306	13,931	18,243	10,740	*17,748	10,563	30.0
1.5 (5 ft)	kg			*17,828	11,811	*12,833	8,121	*10,290	6,077	8,159	4,767	8,032	4,696	9.1
	lb			*39,304	26,040	*28,292	17,903	*22,685	13,398	17,987	10,510	17,708	10,354	30.0
GROUND LEVEL	kg			*18,167	11,546	*13,403	7,860	10,408	5,916			8,217	4,775	8.9
	lb			*40,052	25,454	*29,548	17,329	22,947	13,042			18,115	10,527	29.0
-1.5 (-5 ft)	kg	*15,508	*15,508	*17,457	11,557	*13,246	7,786	10,355	5,869			8,890	5,132	8.4
	lb	*34,188	*34,188	*38,487	25,479	*29,203	17,165	22,829	12,940			19,599	11,315	28.0
-3.0 (-10 ft)	kg	*20,689	*20,689	*15,796	11,747	*12,199	7,881					*9,285	5,987	7.5
	lb	*45,612	*45,612	*34,823	25,898	*26,895	17,374					*20,471	13,199	25.0
-4.5 (-15 ft)	kg	*16,171	*16,171	*12,694	12,145	*9,507	8,206					*8,760	7,740	6.3
	lb	*35,650	*35,650	*27,984	26,776	*20,960	18,092					*19,313	17,064	21.0

LIFTING CAPACITY

936F with 700 mm (28") Shoes, 6,400 mm (21') Boom, 2,900 (9'6") mm Arm

Conditions

Boom length: 6,400 mm (21')
 Arm length: 2,900 mm (9'6")
 Shoes: 700 mm (28")
 Bucket: None
 Unit: kg

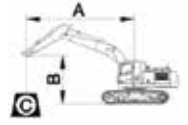

B (m)	A (Unit: m)												MAX REACH		A (m)
	3		4.5		6		7.5		9		Cf	Cs			
	Cf	Cs	Cf	Cs	Cf	Cs	Cf	Cs	Cf	Cs					
6.0 (20 ft)	kg							*8,501	6,885			*8,156	5,950	8.2	
	lb							*18,740	15,178			*17,981	13,118	27.0	
4.5 (15 ft)	kg			*12,911	*12,911	*10,290	9,246	*8,982	6,688			*7,922	5,236	8.8	
	lb			*28,464	*28,464	*22,686	20,383	*19,802	14,745			*17,465	11,544	29.0	
3.0 (10 ft)	kg			*15,911	12,817	*11,677	8,710	*9,664	6,427	8,405	4,959	*8,051	4,877	9.1	
	lb			*35,077	28,258	*25,743	19,203	*21,306	14,169	18,530	10,932	*17,748	10,752	30.0	
1.5 (5 ft)	kg			*17,828	12,020	*12,833	8,263	*10,290	6,185	8,289	4,854	8,160	4,782	9.1	
	lb			*39,304	26,500	*28,292	18,217	*22,685	13,636	18,274	10,702	17,990	10,543	30.0	
GROUND LEVEL	kg			*18,167	11,754	*13,403	8,002	10,574	6,024			8,349	4,863	8.9	
	lb			*40,052	25,914	*29,548	17,642	23,313	13,280			18,406	10,721	29.0	
-1.5 (-5 ft)	kg	*15,508	*15,508	*17,457	11,766	*13,246	7,928	*10,454	5,977			9,032	5,226	8.4	
	lb	*34,188	*34,188	*38,487	25,940	*29,203	17,478	*23,048	13,178			19,913	11,522	28.0	
-3.0 (-10 ft)	kg	*20,689	*20,689	*15,796	11,956	*12,199	8,023					*9,285	6,095	7.5	
	lb	*45,612	*45,612	*34,823	26,358	*26,895	17,688					*20,471	13,437	25.0	
-4.5 (-15 ft)	kg	*16,171	*16,171	*12,694	12,354	*9,507	8,348					*8,760	7,874	6.3	
	lb	*35,650	*35,650	*27,984	27,236	*20,960	18,405					*19,313	17,359	21.0	

LIFTING CAPACITY

936F with 600 mm (24") Shoes, 6,400 mm (21') Boom, 2,600 mm (8'6") Arm

Conditions

Boom length: 6,400 mm (21')
 Arm length: 2,600 mm (8'6")
 Shoes: 600 mm (24")
 Bucket: None
 Unit: kg

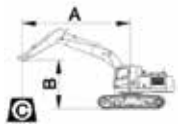

B (m)	A (Unit: m)										MAX REACH		A (m)
	3		4.5		6		7.5		Cf	Cs			
	Cf	Cs	Cf	Cs	Cf	Cs	Cf	Cs					
6.0 (20 ft)	kg					*9,545	9,480	*8,842	6,721	*8,789	6,168	7.9	
	lb					*21,042	20,900	*19,494	14,817	*19,377	13,598	26.0	
4.5 (15 ft)	kg			*13,533	*13,533	*10,644	9,013	*9,249	6,539	*8,775	5,404	8.5	
	lb			*29,835	*29,835	*23,465	19,871	*20,391	14,416	*19,347	11,915	28.0	
3.0 (10 ft)	kg			*16,443	12,340	*11,956	8,476	*9,869	6,284	8,541	5,020	8.8	
	lb			*36,252	27,205	*26,359	18,686	*21,758	13,855	18,830	11,067	29.0	
1.5 (5 ft)	kg			*18,007	11,634	*12,995	8,047	*10,420	6,054	8,427	4,917	8.8	
	lb			*39,699	25,649	*28,650	17,740	*22,973	13,347	18,578	10,840	29.0	
GROUND LEVEL	kg			*17,988	11,468	*13,419	7,818	10,404	5,912	8,632	5,004	8.6	
	lb			*39,656	25,283	*29,585	17,236	22,937	13,034	19,030	11,033	28.0	
-1.5 (-5 ft)	kg	*15,854	*15,854	*17,057	11,537	*13,103	7,780	*10,338	5,896	*9,336	5,400	8.1	
	lb	*34,953	*34,953	*37,605	25,434	*28,888	17,153	*22,792	12,999	*20,582	11,905	27.0	
-3.0 (-10 ft)	kg	*19,213	*19,213	*15,194	11,775	*11,840	7,920			*9,429	6,354	7.2	
	lb	*42,357	*42,357	*33,497	25,958	*26,104	17,461			*20,787	14,009	24.0	
-4.5 (-15 ft)	kg			*11,732	*11,732					*8,979	8,702	5.8	
	lb			*25,865	*25,865					*19,796	19,185	19.0	

LIFTING CAPACITY

936F with 700 mm (28") Shoes, 6,400 mm (21') Boom, 2,600 mm (8'6") Arm

A: Load radius
B: Load point height
C: Lifting capacity rating
Cf: Rating loads over front
Cs: Rating loads over side or 360°

Conditions

Boom length: 6,400 mm (21')
Arm length: 2,600 mm (8'6")
Shoes: 700 mm (28")
Bucket: None
Unit: kg

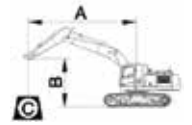

A (Unit: m)

B (m)	A (Unit: m)												A (m)
	3		4.5		6		7.5		MAX REACH				
	Cf	Cs	Cf	Cs	Cf	Cs	Cf	Cs	Cf	Cs	Cf	Cs	
6.0 (20 ft)	kg						*9,545	*9,545	*8,842	6,829	*8,789	6,269	7.9
	lb						*21,042	*21,042	*19,494	15,055	*19,377	13,821	26.0
4.5 (15 ft)	kg			*13,533	*13,533	*10,644	9,156	*9,249	6,647	*8,775	5,497	8.5	
	lb			*29,835	*29,835	*23,465	20,185	*20,391	14,654	*19,347	12,119	28.0	
3.0 (10 ft)	kg			*16,443	12,549	*11,956	8,618	*9,869	6,392	8,675	5,109	8.8	
	lb			*36,252	27,665	*26,359	18,999	*21,758	14,092	19,126	11,263	29.0	
1.5 (5 ft)	kg			*18,007	11,843	*12,995	8,189	*10,420	6,162	8,561	5,006	8.8	
	lb			*39,699	26,109	*28,650	18,054	*22,973	13,585	18,873	11,037	29.0	
GROUND LEVEL	kg			*17,988	11,677	*13,419	7,960	10,570	6,020	8,770	5,096	8.6	
	lb			*39,656	25,743	*29,585	17,550	23,303	13,272	19,335	11,235	28.0	
-1.5 (-5 ft)	kg	*15,854	*15,854	*17,057	11,746	*13,103	7,922	*10,338	6,004	*9,336	5,498	8.1	
	lb	*34,953	*34,953	*37,605	25,894	*28,888	17,466	*22,792	13,236	*20,582	12,122	27.0	
-3.0 (-10 ft)	kg	*19,213	*19,213	*15,194	11,983	*11,840	8,063			*9,429	6,468	7.2	
	lb	*42,357	*42,357	*33,497	26,419	*26,104	17,775			*20,787	14,259	24.0	
-4.5 (-15 ft)	kg			*11,732	*11,732					*8,979	8,851	5.8	
	lb			*25,865	*25,865					*19,796	19,512	19.0	

LIFTING CAPACITY

939F with 600 mm (24") Shoes, 6,400 mm (21') Boom, 3,200 mm (10'6") Arm

A: Load radius
B: Load point height
C: Lifting capacity rating
Cf: Rating loads over front
Cs: Rating loads over side or 360°

Conditions

Boom length: 6,400 mm (21')
Arm length: 3,200 mm (10'6")
Shoes: 600 mm (24")
Bucket: None
Unit: kg

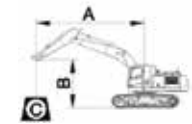

A (Unit: m)

B (m)	A (Unit: m)												A (m)	
	3		4.5		6		7.5		9		MAX REACH			
	Cf	Cs	Cf	Cs	Cf	Cs	Cf	Cs	Cf	Cs	Cf	Cs		
6.0 (20 ft)	kg						*8,170	7,101			*7,295	5,797	8.5	
	lb						*18,012	15,656			*16,082	12,780	28.0	
4.5 (15 ft)	kg					*9,921	9,551	*8,711	6,896	*7,866	5,218	*6,900	5,124	9.1
	lb					*21,871	21,057	*19,204	15,202	*17,343	11,504	*15,212	11,296	30.0
3.0 (10 ft)	kg			*15,350	13,381	*11,374	9,017	*9,449	6,628	*8,377	5,109	*8,025	4,864	9.3
	lb			*33,841	29,499	*25,076	19,879	*20,831	14,613	*18,467	11,262	*17,692	10,723	31.0
1.5 (5 ft)	kg			*17,566	12,511	*12,641	8,552	*10,145	6,376	8,487	4,987	*7,724	4,697	9.4
	lb			*38,727	27,582	*27,869	18,855	*22,365	14,056	18,711	10,995	*17,029	10,356	31.0
GROUND LEVEL	kg			*18,247	12,154	*13,353	8,261	*10,575	6,197	8,397	4,906	8,152	4,773	9.2
	lb			*40,228	26,794	*29,438	18,213	*23,313	13,661	18,513	10,817	17,972	10,523	30.0
-1.5 (-5 ft)	kg	*15,064	*15,064	*17,779	12,106	*13,353	8,153	*10,532	6,124			*8,768	5,112	8.7
	lb	*33,210	*33,210	*39,197	26,689	*29,438	17,974	*23,220	13,502			*19,331	11,271	29.0
-3.0 (-10 ft)	kg	*22,032	*22,032	*16,332	12,249	*12,505	8,208	*9,673	6,191			*8,909	5,831	7.9
	lb	*48,573	*48,573	*36,005	27,004	*27,569	18,096	*21,326	13,648			*19,641	12,855	26.0
-4.5 (-15 ft)	kg	*17,734	*17,734	*13,554	12,586	*10,284	8,458					*8,699	7,386	6.7
	lb	*39,098	*39,098	*29,882	27,746	*22,673	18,647					*19,177	16,284	22.0

LIFTING CAPACITY

939F with 700 mm (28") Shoes, 6,400 mm (21') Boom, 3,200 mm (10'6") Arm

Conditions

A: Load radius
 B: Load point height
 C: Lifting capacity rating
 Cf: Rating loads over front
 Cs: Rating loads over side or 360°

Boom length: 6,400 mm (21')
 Arm length: 3,200 mm (10'6")
 Shoes: 700 mm (28")
 Bucket: None
 Unit: kg

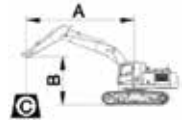

B (m)	A (Unit: m)												MAX REACH		A (m)
	3		4.5		6		7.5		9		Cf	Cs			
	Cf	Cs	Cf	Cs	Cf	Cs	Cf	Cs	Cf	Cs	Cf	Cs			
6.0 (20 ft)	kg							*8,170	7,209			*7,295	5,890	8.5	
	lb							*18,012	15,893			*16,082	12,985	28.0	
4.5 (15 ft)	kg					*9,921	9,693	*8,711	7,004	*7,866	5,305	*6,900	5,210	9.1	
	lb					*21,871	21,370	*19,204	15,440	*17,343	11,695	*15,212	11,485	30.0	
3.0 (10 ft)	kg			*15,350	13,589	*11,374	9,159	*9,449	6,736	*8,377	5,195	*8,025	4,947	9.3	
	lb			*33,841	29,959	*25,076	20,193	*20,831	14,851	*18,467	11,454	*17,692	10,907	31.0	
1.5 (5 ft)	kg			*17,566	12,720	*12,641	8,695	*10,145	6,483	8,617	5,074	*7,724	4,780	9.4	
	lb			*38,727	28,042	*27,869	19,168	*22,365	14,294	18,998	11,187	*17,029	10,538	31.0	
GROUND LEVEL	kg			*18,247	12,362	*13,353	8,403	*10,575	6,304	8,528	4,993	*8,272	4,858	9.2	
	lb			*40,228	27,255	*29,438	18,526	*23,313	13,899	18,800	11,008	*18,238	10,710	30.0	
-1.5 (-5 ft)	kg	*15,064	*15,064	*17,779	12,315	*13,353	8,295	*10,532	6,232			*8,768	5,203	8.7	
	lb	*33,210	*33,210	*39,197	27,149	*29,438	18,287	*23,220	13,739			*19,331	11,470	29.0	
-3.0 (-10 ft)	kg	*22,032	*22,032	*16,332	12,458	*12,505	8,350	*9,673	6,298			*8,909	5,932	7.9	
	lb	*48,573	*48,573	*36,005	27,465	*27,569	18,410	*21,326	13,886			*19,641	13,079	26.0	
-4.5 (-15 ft)	kg	*17,734	*17,734	*13,554	12,794	*10,284	8,600					*8,699	7,510	6.7	
	lb	*39,098	*39,098	*29,882	28,207	*22,673	18,961					*19,177	16,557	22.0	

LIFTING CAPACITY

939F with 600 mm (24") Shoes, 6,400 mm (21') Boom, 2,900 mm (9'6") Arm

Conditions

A: Load radius
 B: Load point height
 C: Lifting capacity rating
 Cf: Rating loads over front
 Cs: Rating loads over side or 360°

Boom length: 6,400 mm (21')
 Arm length: 2,900 mm (9'6")
 Shoes: 600 mm (24")
 Bucket: None
 Unit: kg

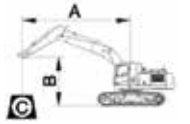

B (m)	A (Unit: m)												MAX REACH		A (m)
	3		4.5		6		7.5		9		Cf	Cs			
	Cf	Cs	Cf	Cs	Cf	Cs	Cf	Cs	Cf	Cs	Cf	Cs			
6.0 (20 ft)	kg							*8,501	7,046			*8,156	6,096	8.2	
	lb							*18,740	15,535			*17,981	13,438	27.0	
4.5 (15 ft)	kg			*12,911	*12,911	*10,290	9,459	*8,982	6,850			*7,922	5,370	8.8	
	lb			*28,464	*28,464	*22,686	20,853	*19,802	15,102			*17,465	11,839	29.0	
3.0 (10 ft)	kg			*15,911	13,131	*11,677	8,923	*9,664	6,589	*8,565	5,089	*8,051	5,005	9.1	
	lb			*35,077	28,948	*25,743	19,673	*21,306	14,525	*18,883	11,219	*17,748	11,035	30.0	
1.5 (5 ft)	kg			*17,828	12,333	*12,833	8,476	*10,290	6,347	8,484	4,984	8,353	4,911	9.1	
	lb			*39,304	27,190	*28,292	18,687	*22,685	13,992	18,704	10,989	18,414	10,826	30.0	
GROUND LEVEL	kg			*18,167	12,068	*13,403	8,216	*10,628	6,185			8,547	4,995	8.9	
	lb			*40,052	26,604	*29,548	18,112	*23,430	13,637			18,843	11,011	29.0	
-1.5 (-5 ft)	kg	*15,508	*15,508	*17,457	12,079	*13,246	8,141	*10,454	6,139			*9,050	5,368	8.4	
	lb	*34,188	*34,188	*38,487	26,630	*29,203	17,948	*23,048	13,534			*19,951	11,834	28.0	
-3.0 (-10 ft)	kg	*20,689	*20,689	*15,796	12,269	*12,199	8,236					*9,285	6,257	7.5	
	lb	*45,612	*45,612	*34,823	27,049	*26,895	18,158					*20,471	13,794	25.0	
-4.5 (-15 ft)	kg	*16,171	*16,171	*12,694	12,667	*9,507	8,562					*8,760	8,074	6.3	
	lb	*35,650	*35,650	*27,984	27,926	*20,960	18,875					*19,313	17,801	21.0	

LIFTING CAPACITY

939F with 700 mm (28") Shoes, 6,400 mm (21') Boom, 2,900 mm (9'6") Arm

Conditions

A: Load radius
 B: Load point height
 C: Lifting capacity rating
 Cf: Rating loads over front
 Cs: Rating loads over side or 360°

Boom length: 6,400 mm (21')
 Arm length: 2,900 mm (9'6")
 Shoes: 700 mm (28")
 Bucket: None
 Unit: kg

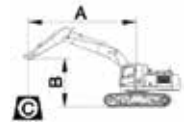

B (m)	A (Unit: m)													
	3		4.5		6		7.5		9		MAX REACH		A (m)	
	Cf	Cs	Cf	Cs	Cf	Cs	Cf	Cs	Cf	Cs	Cf	Cs		
6.0 (20 ft)	kg							*8,501	7,154			*8,156	6,192	8.2
	lb							*18,740	15,772			*17,981	13,652	27.0
4.5 (15 ft)	kg			*12,911	*12,911	*10,290	9,601	*8,982	6,958			*7,922	5,459	8.8
	lb			*28,464	*28,464	*22,686	21,167	*19,802	15,339			*17,465	12,036	29.0
3.0 (10 ft)	kg			*15,911	13,339	*11,677	9,066	*9,664	6,696	*8,565	5,176	*8,051	5,091	9.1
	lb			*35,077	29,408	*25,743	19,986	*21,306	14,763	*18,883	11,410	*17,748	11,224	30.0
1.5 (5 ft)	kg			*17,828	12,542	*12,833	8,618	*10,290	6,455	8,614	5,071	8,481	4,996	9.1
	lb			*39,304	27,650	*28,292	19,000	*22,685	14,230	18,991	11,180	18,697	11,015	30.0
GROUND LEVEL	kg			*18,167	12,276	*13,403	8,358	*10,628	6,293			8,679	5,083	8.9
	lb			*40,052	27,065	*29,548	18,426	*23,430	13,874			19,134	11,205	29.0
-1.5 (-5 ft)	kg	*15,508	*15,508	*17,457	12,288	*13,246	8,283	*10,454	6,247			*9,050	5,462	8.4
	lb	*34,188	*34,188	*38,487	27,090	*29,203	18,262	*23,048	13,772			*19,951	12,041	28.0
-3.0 (-10 ft)	kg	*20,689	*20,689	*15,796	12,478	*12,199	8,378					*9,285	6,365	7.5
	lb	*45,612	*45,612	*34,823	27,509	*26,895	18,471					*20,471	14,031	25.0
-4.5 (-15 ft)	kg	*16,171	*16,171	*12,694	*12,694	*9,507	8,704					*8,760	8,208	6.3
	lb	*35,650	*35,650	*27,984	*27,984	*20,960	19,189					*19,313	18,095	21.0

LIFTING CAPACITY

939F with 600 mm (24") Shoes, 6,400 mm (21') Boom, 2,600 mm (8'6") Arm

Conditions

A: Load radius
 B: Load point height
 C: Lifting capacity rating
 Cf: Rating loads over front
 Cs: Rating loads over side or 360°

Boom length: 6,400 mm (21')
 Arm length: 2,600 mm (8'6")
 Shoes: 600 mm (24")
 Bucket: None
 Unit: kg

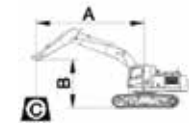

B (m)	A (Unit: m)													
	3		4.5		6		7.5		MAX REACH		A (m)			
	Cf	Cs	Cf	Cs	Cf	Cs	Cf	Cs	Cf	Cs				
6.0 (20 ft)	kg					*9,545	*9,545	*8,842	6,991	*8,789	6,421		7.9	
	lb					*21,042	*21,042	*19,494	15,412	*19,377	14,156		26.0	
4.5 (15 ft)	kg			*13,533	*13,533	*10,644	9,369	*9,249	6,809	*8,775	5,637		8.5	
	lb			*29,835	*29,835	*23,465	20,655	*20,391	15,010	*19,347	12,427		28.0	
3.0 (10 ft)	kg			*16,443	12,862	*11,956	8,831	*9,869	6,554	*8,865	5,243		8.8	
	lb			*36,252	28,356	*26,359	19,469	*21,758	14,449	*19,545	11,558		29.0	
1.5 (5 ft)	kg			*18,007	12,156	*12,995	8,402	*10,420	6,324	8,762	5,140		8.8	
	lb			*39,699	26,800	*28,650	18,524	*22,973	13,941	19,316	11,332		29.0	
GROUND LEVEL	kg			*17,988	11,990	*13,419	8,174	*10,661	6,182	8,977	5,233		8.6	
	lb			*39,656	26,433	*29,585	18,020	*23,504	13,628	19,791	11,538		28.0	
-1.5 (-5 ft)	kg	*15,854	*15,854	*17,057	12,059	*13,103	8,136	*10,338	6,166	*9,336	5,646		8.1	
	lb	*34,953	*34,953	*37,605	26,585	*28,888	17,936	*22,792	13,593	*20,582	12,447		27.0	
-3.0 (-10 ft)	kg	*19,213	*19,213	*15,194	12,296	*11,840	8,276			*9,429	6,638		7.2	
	lb	*42,357	*42,357	*33,497	27,109	*26,104	18,245			*20,787	14,634		24.0	
-4.5 (-15 ft)	kg			*11,732	*11,732					*8,979	*8,979		5.8	
	lb			*25,865	*25,865					*19,796	*19,796		19.0	



LIFTING CAPACITY

939F with 700 mm (28") Shoes, 6,400 mm (21') Boom, 2,600 mm (8'6") Arm

Conditions

A: Load radius
 B: Load point height
 C: Lifting capacity rating
 Cf: Rating loads over front
 Cs: Rating loads over side or 360°

Boom length: 6,400 mm (21')
 Arm length: 2,600 mm (8'6")
 Shoes: 700 mm (28")
 Bucket: None
 Unit: kg



B (m)	A (Unit: m)											
	3		4.5		6		7.5		MAX REACH		A (m)	
	Cf	Cs	Cf	Cs	Cf	Cs	Cf	Cs	Cf	Cs		
6.0 (20 ft)	kg					*9,545	*9,545	*8,842	7,098	*8,789	6,522	7.9
	lb					*21,042	*21,042	*19,494	15,649	*19,377	14,380	26.0
4.5 (15 ft)	kg			*13,533	*13,533	*10,644	9,511	*9,249	6,916	*8,775	5,729	8.5
	lb			*29,835	*29,835	*23,465	20,968	*20,391	15,248	*19,347	12,631	28.0
3.0 (10 ft)	kg			*16,443	13,071	*11,956	8,973	*9,869	6,662	*8,865	5,332	8.8
	lb			*36,252	28,816	*26,359	19,783	*21,758	14,687	*19,545	11,755	29.0
1.5 (5 ft)	kg			*18,007	12,365	*12,995	8,544	*10,420	6,432	8,895	5,229	8.8
	lb			*39,699	27,260	*28,650	18,837	*22,973	14,179	19,611	11,528	29.0
GROUND LEVEL	kg			*17,988	12,199	*13,419	8,316	*10,661	6,289	9,115	5,325	8.6
	lb			*39,656	26,894	*29,585	18,334	*23,504	13,866	20,095	11,740	28.0
-1.5 (-5 ft)	kg	*15,854	*15,854	*17,057	12,267	*13,103	8,278	*10,338	6,273	*9,336	5,744	8.1
	lb	*34,953	*34,953	*37,605	27,045	*28,888	18,250	*22,792	13,831	*20,582	12,664	27.0
-3.0 (-10 ft)	kg	*19,213	*19,213	*15,194	12,505	*11,840	8,418			*9,429	6,751	7.2
	lb	*42,357	*42,357	*33,497	27,569	*26,104	18,559			*20,787	14,883	24.0
-4.5 (-15 ft)	kg			*11,732	*11,732					*8,979	*8,979	5.8
	lb			*25,865	*25,865					*19,796	*19,796	19.0

LIFTING CAPACITY

942F with 600 mm (24") Shoes, 6,400 mm (21') Boom, 3,200 mm (10'6") Arm

Conditions

A: Load radius
 B: Load point height
 C: Lifting capacity rating
 Cf: Rating loads over front
 Cs: Rating loads over side or 360°

Boom length: 6,400 mm (21')
 Arm length: 3,200 mm (10'6")
 Shoes: 600 mm (24")
 Bucket: None
 Unit: kg



B (m)	A (Unit: m)													
	3		4.5		6		7.5		9		MAX REACH		A (m)	
	Cf	Cs	Cf	Cs	Cf	Cs	Cf	Cs	Cf	Cs	Cf	Cs		
6.0 (20 ft)	kg							*8,170	7,651			*7,295	6,256	8.5
	lb							*18,012	16,868			*16,082	13,792	28.0
4.5 (15 ft)	kg					*9,921	*9,921	*8,711	7,443	*7,866	5,641	*6,900	5,541	9.1
	lb					*21,871	*21,871	*19,204	16,409	*17,343	12,437	*15,212	12,215	30.0
3.0 (10 ft)	kg			*15,350	14,608	*11,374	9,776	*9,449	7,172	*8,377	5,531	*8,025	5,268	9.3
	lb			*33,841	32,205	*25,076	21,552	*20,831	15,812	*18,467	12,193	*17,692	11,613	31.0
1.5 (5 ft)	kg			*17,566	13,717	*12,641	9,304	*10,145	6,917	*8,674	5,408	*7,724	5,095	9.4
	lb			*38,727	30,241	*27,869	20,511	*22,365	15,248	*19,122	11,923	*17,029	11,232	31.0
GROUND LEVEL	kg			*18,247	13,352	*13,353	9,008	*10,575	6,735	*8,769	5,327	*8,272	5,181	9.2
	lb			*40,228	29,435	*29,438	19,859	*23,313	14,849	*19,333	11,743	*18,238	11,423	30.0
-1.5 (-5 ft)	kg	*15,064	*15,064	*17,779	13,303	*13,353	8,898	*10,532	6,662			*8,768	5,552	8.7
	lb	*33,210	*33,210	*39,197	29,327	*29,438	19,616	*23,220	14,688			*19,331	12,240	29.0
-3.0 (-10 ft)	kg	*22,032	*22,032	*16,332	13,449	*12,505	8,954	*9,673	6,729			*8,909	6,333	7.9
	lb	*48,573	*48,573	*36,005	29,650	*27,569	19,740	*21,326	14,836			*19,641	13,961	26.0
-4.5 (-15 ft)	kg	*17,734	*17,734	*13,554	*13,554	*10,284	9,208					*8,699	8,023	6.7
	lb	*39,098	*39,098	*29,882	*29,882	*22,673	20,301					*19,177	17,687	22.0

LIFTING CAPACITY

942F with 700 mm (28") Shoes, 6,400 mm (21') Boom, 3,200 mm (10'6") Arm

Conditions

A: Load radius
 B: Load point height
 C: Lifting capacity rating
 Cf: Rating loads over front
 Cs: Rating loads over side or 360°

Boom length: 6,400 mm (21')
 Arm length: 3,200 mm (10'6")
 Shoes: 700 mm (28")
 Bucket: None
 Unit: kg

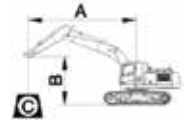

B (m)	A (Unit: m)													A (m)
	3		4.5		6		7.5		9		MAX REACH			
	Cf	Cs	Cf	Cs	Cf	Cs	Cf	Cs	Cf	Cs	Cf	Cs		
6.0 (20 ft)	kg							*8,170	7,764			*7,295	6,353	8.5
	lb							*18,012	17,116			*16,082	14,006	28.0
4.5 (15 ft)	kg					*9,921	*9,921	*8,711	7,556	*7,866	5,732	*6,900	5,630	9.1
	lb					*21,871	*21,871	*19,204	16,658	*17,343	12,637	*15,212	12,412	30.0
3.0 (10 ft)	kg			*15,350	14,829	*11,374	9,925	*9,449	7,285	*8,377	5,621	*8,025	5,355	9.3
	lb			*33,841	32,692	*25,076	21,882	*20,831	16,061	*18,467	12,393	*17,692	11,806	31.0
1.5 (5 ft)	kg			*17,566	13,938	*12,641	9,453	*10,145	7,029	*8,674	5,499	*7,724	5,181	9.4
	lb			*38,727	30,728	*27,869	20,841	*22,365	15,497	*19,122	12,123	*17,029	11,421	31.0
GROUND LEVEL	kg			*18,247	13,572	*13,353	9,157	*10,575	6,848	*8,769	5,417	*8,272	5,270	9.2
	lb			*40,228	29,922	*29,438	20,188	*23,313	15,098	*19,333	11,943	*18,238	11,617	30.0
-1.5 (-5 ft)	kg	*15,064	*15,064	*17,779	13,523	*13,353	9,047	*10,532	6,775			*8,768	5,646	8.7
	lb	*33,210	*33,210	*39,197	29,814	*29,438	19,945	*23,220	14,936			*19,331	12,448	29.0
-3.0 (-10 ft)	kg	*22,032	*22,032	*16,332	13,670	*12,505	9,103	*9,673	6,842			*8,909	6,438	7.9
	lb	*48,573	*48,573	*36,005	30,137	*27,569	20,070	*21,326	15,084			*19,641	14,194	26.0
-4.5 (-15 ft)	kg	*17,734	*17,734	*13,554	*13,554	*10,284	9,358					*8,699	8,152	6.7
	lb	*39,098	*39,098	*29,882	*29,882	*22,673	20,630					*19,177	17,973	22.0

LIFTING CAPACITY

942F with 600 mm (24") Shoes, 6,400 mm (21') Boom, 2,900 mm (9'6") Arm

Conditions

A: Load radius
 B: Load point height
 C: Lifting capacity rating
 Cf: Rating loads over front
 Cs: Rating loads over side or 360°

Boom length: 6,400 mm (21')
 Arm length: 2,900 mm (9'6")
 Shoes: 600 mm (24")
 Bucket: None
 Unit: kg

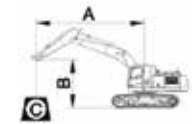

B (m)	A (Unit: m)													A (m)
	3		4.5		6		7.5		9		MAX REACH			
	Cf	Cs	Cf	Cs	Cf	Cs	Cf	Cs	Cf	Cs	Cf	Cs		
6.0 (20 ft)	kg							*8,501	7,596			*8,156	6,578	8.2
	lb							*18,740	16,745			*17,981	14,502	27.0
4.5 (15 ft)	kg			*12,911	*12,911	*10,290	10,225	*8,982	7,397			*7,922	5,806	8.8
	lb			*28,464	*28,464	*22,686	22,542	*19,802	16,307			*17,465	12,801	29.0
3.0 (10 ft)	kg			*15,911	14,352	*11,677	9,681	*9,664	7,132	*8,565	5,511	*8,051	5,421	9.1
	lb			*35,077	31,640	*25,743	21,343	*21,306	15,724	*18,883	12,149	*17,748	11,952	30.0
1.5 (5 ft)	kg			*17,828	13,535	*12,833	9,226	*10,290	6,887	*8,780	5,405	*8,697	5,326	9.1
	lb			*39,304	29,840	*28,292	20,341	*22,685	15,184	*19,357	11,917	*19,173	11,741	30.0
GROUND LEVEL	kg			*18,167	13,263	*13,403	8,962	*10,628	6,724			*8,867	5,421	8.9
	lb			*40,052	29,240	*29,548	19,757	*23,430	14,824			*19,548	11,952	29.0
-1.5 (-5 ft)	kg	*15,508	*15,508	*17,457	13,275	*13,246	8,886	*10,454	6,677			*9,050	5,829	8.4
	lb	*34,188	*34,188	*38,487	29,267	*29,203	19,590	*23,048	14,720			*19,951	12,850	28.0
-3.0 (-10 ft)	kg	*20,689	*20,689	*15,796	13,470	*12,199	8,983					*9,285	6,796	7.5
	lb	*45,612	*45,612	*34,823	29,696	*26,895	19,803					*20,471	14,983	25.0
-4.5 (-15 ft)	kg	*16,171	*16,171	*12,694	*12,694	*9,507	9,313					*8,760	*8,760	6.3
	lb	*35,650	*35,650	*27,984	*27,984	*20,960	20,532					*19,313	*19,313	21.0

LIFTING CAPACITY

942F with 700 mm (28") Shoes, 6,400 mm (21') Boom, 2,900 mm (9'6") Arm

Conditions

Boom length: 6,400 mm (21')
 Arm length: 2,900 mm (9'6")
 Shoes: 700 mm (28")
 Bucket: None
 Unit: kg

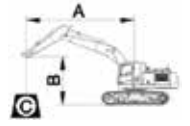

B (m)	A (Unit: m)												A (m)	
	3		4.5		6		7.5		9		MAX REACH			
	Cf	Cs	Cf	Cs	Cf	Cs	Cf	Cs	Cf	Cs	Cf	Cs		
6.0 (20 ft)	kg							*8,501	7,708			*8,156	6,679	8.2
	lb							*18,740	16,994			*17,981	14,725	27.0
4.5 (15 ft)	kg			*12,911	*12,911	*10,290	*10,290	*8,982	7,510			*7,922	5,899	8.8
	lb			*28,464	*28,464	*22,686	*22,686	*19,802	16,556			*17,465	13,006	29.0
3.0 (10 ft)	kg			*15,911	14,573	*11,677	9,830	*9,664	7,245	*8,565	5,601	*8,051	5,511	9.1
	lb			*35,077	32,127	*25,743	21,672	*21,306	15,972	*18,883	12,349	*17,748	12,149	30.0
1.5 (5 ft)	kg			*17,828	13,756	*12,833	9,376	*10,290	7,000	*8,780	5,496	*8,697	5,415	9.1
	lb			*39,304	30,327	*28,292	20,670	*22,685	15,433	*19,357	12,117	*19,173	11,938	30.0
GROUND LEVEL	kg			*18,167	13,484	*13,403	9,111	*10,628	6,837			*8,867	5,513	8.9
	lb			*40,052	29,728	*29,548	20,086	*23,430	15,073			*19,548	12,154	29.0
-1.5 (-5 ft)	kg	*15,508	*15,508	*17,457	13,496	*13,246	9,035	*10,454	6,790			*9,050	5,927	8.4
	lb	*34,188	*34,188	*38,487	29,754	*29,203	19,920	*23,048	14,969			*19,951	13,067	28.0
-3.0 (-10 ft)	kg	*20,689	*20,689	*15,796	13,691	*12,199	9,132					*9,285	6,909	7.5
	lb	*45,612	*45,612	*34,823	30,183	*26,895	20,132					*20,471	15,232	25.0
-4.5 (-15 ft)	kg	*16,171	*16,171	*12,694	*12,694	*9,507	9,463					*8,760	*8,760	6.3
	lb	*35,650	*35,650	*27,984	*27,984	*20,960	20,862					*19,313	*19,313	21.0

LIFTING CAPACITY

942F with 600 mm (24") Shoes, 6,400 mm (21') Boom, 2,600 mm (8'6") Arm

Conditions

Boom length: 6,400 mm (21')
 Arm length: 2,600 mm (8'6")
 Shoes: 600 mm (24")
 Bucket: None
 Unit: kg

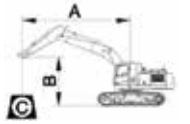

B (m)	A (Unit: m)										A (m)	
	3		4.5		6		7.5		MAX REACH			
	Cf	Cs	Cf	Cs	Cf	Cs	Cf	Cs	Cf	Cs		
6.0 (20 ft)	kg					*9,545	*9,545	*8,842	7,539	*8,789	6,930	7.9
	lb					*21,042	*21,042	*19,494	16,621	*19,377	15,277	26.0
4.5 (15 ft)	kg			*13,533	*13,533	*10,644	10,134	*9,249	7,355	*8,775	6,094	8.5
	lb			*29,835	*29,835	*23,465	22,341	*20,391	16,214	*19,347	13,435	28.0
3.0 (10 ft)	kg			*16,443	14,077	*11,956	9,587	*9,869	7,097	*8,865	5,678	8.8
	lb			*36,252	31,034	*26,359	21,136	*21,758	15,646	*19,545	12,517	29.0
1.5 (5 ft)	kg			*18,007	13,354	*12,995	9,151	*10,420	6,864	*9,048	5,574	8.8
	lb			*39,699	29,441	*28,650	20,175	*22,973	15,133	*19,947	12,288	29.0
GROUND LEVEL	kg			*17,988	13,184	*13,419	8,919	*10,661	6,720	*9,204	5,680	8.6
	lb			*39,656	29,066	*29,585	19,663	*23,504	14,815	*20,290	12,523	28.0
-1.5 (-5 ft)	kg	*15,854	*15,854	*17,057	13,254	*13,103	8,880	*10,338	6,704	*9,336	6,130	8.1
	lb	*34,953	*34,953	*37,605	29,220	*28,888	19,578	*22,792	14,780	*20,582	13,515	27.0
-3.0 (-10 ft)	kg	*19,213	*19,213	*15,194	13,498	*11,840	9,023			*9,429	7,210	7.2
	lb	*42,357	*42,357	*33,497	29,757	*26,104	19,892			*20,787	15,895	24.0
-4.5 (-15 ft)	kg			*11,732	*11,732					*8,979	*8,979	5.8
	lb			*25,865	*25,865					*19,796	*19,796	19.0

LIFTING CAPACITY

942F with 700 mm (28") Shoes, 6,400 mm (21') Boom, 2,600 mm (8'6") Arm

Conditions

A: Load radius
 B: Load point height
 C: Lifting capacity rating
 Cf: Rating loads over front
 Cs: Rating loads over side or 360°

Boom length: 6,400 mm (21')
 Arm length: 2,600 mm (8'6")
 Shoes: 700 mm (28")
 Bucket: None
 Unit: kg

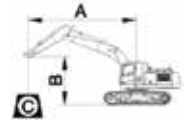

A (Unit: m)

B (m)		3		4.5		6		7.5		MAX REACH		A (m)
		Cf	Cs	Cf	Cs	Cf	Cs	Cf	Cs	Cf	Cs	
6.0 (20 ft)	kg					*9,545	*9,545	*8,842	7,652	*8,789	7,035	7.9
	lb					*21,042	*21,042	*19,494	16,869	*19,377	15,510	26.0
4.5 (15 ft)	kg			*13,533	*13,533	*10,644	10,283	*9,249	7,468	*8,775	6,191	8.5
	lb			*29,835	*29,835	*23,465	22,670	*20,391	16,463	*19,347	13,648	28.0
3.0 (10 ft)	kg			*16,443	14,298	*11,956	9,736	*9,869	7,210	*8,865	5,771	8.8
	lb			*36,252	31,521	*26,359	21,465	*21,758	15,895	*19,545	12,722	29.0
1.5 (5 ft)	kg			*18,007	13,575	*12,995	9,301	*10,420	6,977	*9,048	5,667	8.8
	lb			*39,699	29,928	*28,650	20,504	*22,973	15,381	*19,947	12,493	29.0
GROUND LEVEL	kg			*17,988	13,405	*13,419	9,068	*10,661	6,833	*9,204	5,776	8.6
	lb			*39,656	29,553	*29,585	19,992	*23,504	15,064	*20,290	12,734	28.0
-1.5 (-5 ft)	kg	*15,854	*15,854	*17,057	13,475	*13,103	9,030	*10,338	6,817	*9,336	6,233	8.1
	lb	*34,953	*34,953	*37,605	29,707	*28,888	19,907	*22,792	15,028	*20,582	13,742	27.0
-3.0 (-10 ft)	kg	*19,213	*19,213	*15,194	13,719	*11,840	9,172			*9,429	7,328	7.2
	lb	*42,357	*42,357	*33,497	30,244	*26,104	20,221			*20,787	16,156	24.0
-4.5 (-15 ft)	kg			*11,732	*11,732					*8,979	*8,979	5.8
	lb			*25,865	*25,865					*19,796	*19,796	19.0

STANDARD EQUIPMENT

ENGINE SYSTEM

	936F DM	930F	936F	939F DM	942F
• Cummins B6.7 engine, Rate power 173kW,EPA Tier 4F/EU Stage V, turbocharged, 6 cylinder, 4 stroke, water cooled.	■	■	-	-	-
• Cummins L9 engine, Rate power 231kW,EPA Tier 4F/EU Stage V, turbocharged, 6 cylinder, 4 stroke, water cooled.	-	-	■	■	■
• Engine overheat prevention system	■	■	■	■	■
• Auto-idle speed control	■	■	■	■	■
• Automatic engine shutdown	■	■	■	■	■
• Radial seal air filters (primary and secondary filter)	■	■	■	■	■
• Cleanable metal fuel tank	■	■	■	■	■
• Fuel pre-filter with water separator and water detection	■	■	■	■	■
• Electric fuel lifting pump	■	■	■	■	■
• Remote engine oil filter	■	■	■	■	■
• Variable fan with viscous clutch	■	■	■	■	■
• Removable Radiator dustproof net	■	■	■	■	■
• Air conditioner compressor belt automatic tense	■	■	■	■	■
• Cold starting kit for -20° C	■	■	■	■	■
• Engine oil low pressure protection	■	■	■	■	■
• Automatic warming up	■	■	■	■	■
• Coolant level warning	■	■	■	■	■
• Supercharger thermal protection	■	■	■	■	■
• DEF level alarm	■	■	■	■	■
• Fuel pressure differential gauge	■	■	■	■	■
• Air prefilter	■	■	■	■	■
• Warning for air filter block	■	■	■	■	■
• Drain coolant at outer side of radiator	■	■	■	■	■
• Coolant level observed on ground	■	■	■	■	■
• Easy to drain engine oil (bottom cover with drain valve)	■	■	■	■	■
• Fuel shut-off valve	■	■	■	■	■
• Water drainable fuel tank(with water valve)	■	■	■	■	■

HYDRAULIC SYSTEM

	936F DM	930F	936F	939F DM	942F
• Full electric control hydraulic system	■	■	■	■	■
• 3-power modes (Power, Standard, Economy)	■	■	■	■	■
• Power boost function	■	■	■	■	■
• Pilot control shut-off lever	■	■	■	■	■
• Pilot accumulator	■	■	■	■	■
• Low force joystick	■	■	■	■	■
• Automatic swing parking brake	■	■	■	■	■
• Swing with anti-reverse function	■	■	■	■	■

- Boom and arm regeneration circuits
- Boom and arm holding valves
- Automatic two-speed travel
- Automatic travel parking brake
- Pressure checking port for main pump
- MCV with auxiliary valve
- Boom and arm down lock valve
- Hydraulic oil level visible
- Hydraulic pump with PTO port

■	■	■	■	■
■	■	■	■	■
■	■	■	■	■
■	■	■	■	■
■	■	■	■	■
■	■	■	■	■
■	■	■	■	■
■	■	■	■	■
■	■	■	■	■

OPERATOR STATION

936F DM 930F 936F 939F DM 942F

- Pressurized and sealed cab with all-around visibility
- ROPS certified cab
- Lower windshield can be removable
- Openable front windshield with assist device
- Large roof window with slide sliding sun visor
- Air suspension deluxe seat (with heater and head rest) +retractable seat belt (75 mm [3 in] width, red colour, with green alarm lamp)
- Consoles and seat height adjustable follow-up
- 8 inches high resolution LCD touch screen + integrated control panel
- Washable floor mat
- Fire extinguisher
- Safety hammer for cab evacuation
- Green safety glass
- Cab interior lighting
- Cab emergency exit
- Fire extinguisher bracket
- Travel control pedals with removable hand levers
- Sliding upper door window(left-hand cab door)
- Rear view mirror, mounted in the LH cab

■	■	■	■	■
■	■	■	■	■
■	■	■	■	■
■	■	■	■	■
■	■	■	■	■
■	■	■	■	■
■	■	■	■	■
■	■	■	■	■
■	■	■	■	■
■	■	■	■	■
■	■	■	■	■
■	■	■	■	■
■	■	■	■	■
■	■	■	■	■
■	■	■	■	■
■	■	■	■	■
■	■	■	■	■
■	■	■	■	■
■	■	■	■	■
■	■	■	■	■
■	■	■	■	■
■	■	■	■	■

ELECTRICAL SYSTEM

936F DM 930F 936F 939F DM 942F

- Monitor: working mode, working hour, water temperature, oil temperature, fuel level, DEF level, fuel consumption, rear vision, fault code, work condition etc. machine information.
- Warn: low engine oil pressure, low fuel level, air filter clog, machine overheat, maintenance remind etc.
- Front window wiper with time adjustable intermittent feature
- AM/FM radio with auxiliary input
- Blue tooth
- Working lights close time delay by programmable
- Cab interior decoration lights close time delay by programmable
- 2 stereo speakers
- Battery disconnect switch
- Emergency stop on ground
- Set password for auxiliary hydraulic-flow adjustments
- Work tool flow and pressure programmable memories

■	■	■	■	■
■	■	■	■	■
■	■	■	■	■
■	■	■	■	■
■	■	■	■	■
■	■	■	■	■
■	■	■	■	■
■	■	■	■	■
■	■	■	■	■
■	■	■	■	■
■	■	■	■	■
■	■	■	■	■
■	■	■	■	■
■	■	■	■	■
■	■	■	■	■
■	■	■	■	■
■	■	■	■	■
■	■	■	■	■
■	■	■	■	■
■	■	■	■	■
■	■	■	■	■
■	■	■	■	■

50 Front window wiper gating switch

<ul style="list-style-type: none"> Instantaneous fuel consumption display 2 Batteries Language display (full graphic and full color display) Engine auto pre-heater Plateau mode (plateau adaptive function) Travel alarm Auto power boost 	■	■	■	■	■
---	---	---	---	---	---

UNDERCARRIAGE	936F DM	930F	936F	939F DM	942F
----------------------	----------------	-------------	-------------	----------------	-------------

<ul style="list-style-type: none"> Guard package: HD bottom guard Rollers, bottom - 9 each side Rollers, top - 2 each side Centralized lubrication for swing bearing Towing eye on base frame Guard package: Heavy-duty travel motor guard 	■	■	■	■	■
--	---	---	---	---	---

UPPER STRUCTURE	936F DM	930F	936F	939F DM	942F
------------------------	----------------	-------------	-------------	----------------	-------------

<ul style="list-style-type: none"> Frame handrail Punched metal anti-slip plates Foot pedal is in engine room Engine chamber and main pump chamber separated by fire board Side door brace automatically lock Rearview mirror mounted in the RH machine Lockable tool box Grease point in front of platform Counterweight reserved rear view instrument installation 	■	■	■	■	■
---	---	---	---	---	---

DIGGING EQUIPMENT	936F DM	930F	936F	939F DM	942F
--------------------------	----------------	-------------	-------------	----------------	-------------

<ul style="list-style-type: none"> 6,200 mm boom 6,400 mm boom Arm front end with guard bars Manual centralized lubrication on boom Manual centralized lubrication on arm Hammer pipe support Quick coupler pipe support 	■	■	■	■	■
---	---	---	---	---	---

AIR CONDITIONING SYSTEM	936F DM	930F	936F	939F DM	942F
--------------------------------	----------------	-------------	-------------	----------------	-------------

<ul style="list-style-type: none"> Automatic air conditioner, heater, defroster Refrigerant observation hole on side Wind renewal function 	■	■	■	■	■
---	---	---	---	---	---

SERVICE & MAINTENANCE	936F DM	930F	936F	939F DM	942F
----------------------------------	----------------	-------------	-------------	----------------	-------------

<ul style="list-style-type: none"> Maintenance tool kit Maintenance parts package Data diagnostic port Self-diagnostic system 	■	■	■	■	■
---	---	---	---	---	---

• Machine rear lighting	■	■	■	■	■
• Work lights: separately installed LED in front and rear cab (4 front and 2 rear)	-	■	-	-	-
• Work lights: long strip LED light in front and rear cab	■	-	■	■	■
• Capability to electrically connect beacon	■	■	■	■	■
• 12V power supply	■	■	■	■	■

UNDERCARRIAGE

	936F DM	930F	936F	939F DM	942F
• 942F undercarriage (Length to center of Rollers 4,250 mm, Track Gauge 2,740 mm)	-	-	-	-	■
• Heavy duty undercarriage (Length to center of Rollers 4,140 mm, Track Gauge 2,590 mm)	■	■	■	■	-
• 600 mm track-shoes with triple grousers	□	□	□	□	□
• 700 mm track-shoes with triple grousers	■	■	■	■	■
• 800 mm track-shoes with triple grousers	□	□	□	□	□
• 900 mm track-shoes with triple grousers	□	□	□	□	□
• Auxiliary tarck footrest	■	■	■	■	■
• 2 piece track guards (each side)	■	■	■	■	-
• 3 piece track guards (each side)	□	□	□	□	-
• Full length track guiding guard	-	-	-	-	■

UPPER STRUCTURE

	936F DM	930F	936F	939F DM	942F
• Guard rails of upper frame sides	■	■	■	■	■
• Guard fence of upper frame around	■	-	■	■	■
• Assembly Upper frame guard	■	-	-	■	■
• Standard frame undercover	-	■	-	-	-
• Reinforced frame undercover	■	-	■	■	■
• 5,800 kg counterweight	-	■	-	-	-
• 6,700 kg counterweight	■	-	-	-	-
• 7,700 kg counterweight	-	-	■	-	-
• 8,500 kg counterweight	-	-	-	■	-
• 9,000 kg counterweight	-	-	-	-	■

DIGGING EQUIPMENT

	936F DM	930F	936F	939F DM	942F
• 2,600 mm short reach arm	■	■	□	□	□
• 2,900 mm short reach arm	-	-	□	□	□
• 3,050 mm arm	■	-	-	-	-
• 3,200 mm arm	-	-	■	■	■
• Bucket cylinder rod protect	-	-	-	■	■
• 1.4 m ³ general bucket	-	-	-	-	-
• 1.6 m ³ general bucket	-	-	-	-	-
• 1.8 m ³ general bucket	-	-	-	-	-
• 2.0 m ³ general bucket (need 2600mm arm or 2900mm arm)	-	-	-	-	-
• Hydraulic quick coupler	-	-	-	-	-

SERVICE & MAINTENANCE

	936F DM	930F	936F	939F DM	942F
• iLink	■	■	■	■	■





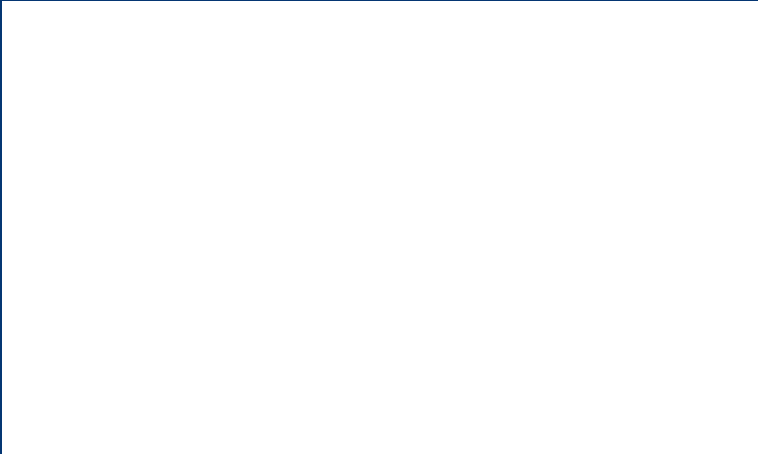

TOUGH WORLD. TOUGH EQUIPMENT.

Guangxi LiuGong Machinery Co., Ltd.
No. 1 Liutai Road, Liuzhou, Guangxi 545007, PR China
T: +86 772 388 6124 E: overseas@liugong.com
www.liugong.com

Like and follow us:



LG-PB-930F 933F 936F 939F 942F-Stage V-56-19092022-ENG

The LiuGong series of logos herein, including but not limited to word marks, device marks, letter of alphabet marks and combination marks, as the registered trademarks of Guangxi LiuGong Group Co., Ltd. are used by Guangxi LiuGong Machinery Co., Ltd. with legal permission, and shall not be used without permission. Specifications and designs are subject to change without notice. Illustrations and pictures may include optional equipment and may not include all standard equipment. Equipment and options varies by regional availability.